

Massive Muscle Pumping



**Gain 25 Pounds in (A) 21 Day
(Mass Up Cycle)**

By Dennis B. Weis "The Yukon Hercules"

Distributed by www.criticalbench.com

“CRASH THE MASS MUSCLE BARRIER AND GAIN 25 POUNDS IN 21 DAYS!”

There have been many training programs developed over the years for **crashing the mass muscle barrier**. Four of the most up to date and extensive programs that come to mind are: **Big Beyond Belief & Titan Training** (www.otsdirect.com) **Anabolic Training “A High Intensity Program for 20 Pounds of Muscle in 4 Weeks”** (www.drjudd.net), and **SIZE SURGE** (www.home-gym.com). I have read them all but one of the most dynamic and unorthodox advanced training programs for **crashing the mass muscle barrier** was the one used by a New York City bodybuilder named Richard Simons back in the 1960's.

I was living in Miami, Florida in 1966 and I was introduced to Richard Simons (who was in town for a visit) through two of our mutual iron game friends **Donne Hale**, the owner of '**Hales Fitness and Figure Gym**', and **John Carl Mese**. I told Richard that I recognized his name from his great training articles that were being published in Peary Rader's "Iron Man" magazine.

It wasn't long before Richard and I struck up a conversation about our favorite passion, bodybuilding. As we began to converse Richard told he had just recently completed a rather intensive **21 Day (Mass Up Cycle)** and had gained **25 Pounds** in the process. Now a lot of bodybuilders talk "smack" but I had a feeling this wasn't the case with this prolific bodybuilding writer.

He began to speak in more detail and said that previous to embarking upon the intensive **21 Day (Mass Up Cycle)** he had been following a training program from the orient that many of the Nippon (Japanese) bodybuilders were using with great success. Basically it was a counter-split which consisted of **SIX-DAYS-A-WEEK FULL-BODY BLAST WORKOUTS**.

Richard explained that the whole-body was **bulked (power pumped)** on Monday-Wednesday and Friday. Countering (hence the term "counter-split") those training days, the whole-body was **shaped** on the intervening days (Tuesday-Thursday-Saturday).

He said that this counter-split training system was an adaptation of the famous Joe Weider Split Routine system and that it was revolutionizing Japanese bodybuilding!

Here's an encapsulated and revealing look at the...

JAPANESE COUNTER-SPLIT BODY BLAST SYSTEM!



Shigeru Sugita a Mr. Japan champion

Monday-Wednesday-Friday

MUSCLE BULK AND SIZE PROGRAM

Thighs-Heavy Barbell Back Squats, Thigh Biceps Curl

Chest-Heavy Barbell Bench Press, Bent Arm Pullover, Incline Barbell Press
Back-Wide Grip Pull-ups w/weight, Heavy One Arm Dumbbell Rowing,
Barbell Shrugs

Shoulders-Heavy Barbell Press Behind Neck, Heavy Dumbbell Press; (prior chest work produces balance of shoulder program)

Biceps-Cheat Barbell Curls, Alternate Cheat Dumbbell Curls, (seated)

Triceps-Heavy Triceps Press, (standing or seated); **Narrow Grip Cheat Bench Press**

Calves-Donkey Calf Raise, Heel Raises on Vertical Leg Press Machine

Abdominals-None

Bulk exercises and **low reps** of (6) prevailed; using **moderate** to **heavy weight**. **Five to nine sets** are performed for the major muscle groups of the thighs, back and chest and **3 to 5 sets** for the minor muscle groups (Shoulders, Triceps, Biceps, Abdominals and Calves). **Rest between sets is around two-five minutes.**

Tuesday-Thursday-Saturday

MUSCLE SHAPE PROGRAM

Thighs-Sissy Squats, Leg Extensions
Chest-Criss-Crosses w/Cables, Dumbbell Flyes
Back-Bent-Over Barbell Rows, Lat Attachment Bar Chins
Shoulders-Dumbbell Lateral or Rear Raises, Lateral Raise w/Cables
Biceps-Dumbbell seated Concentration Curl, Scott Bench Curl
Triceps-Dumbbell Triceps Kickback, Strict Lat Bar Pushdowns
Calves-One-legged Calf Raise, Running up stairs on toes
Abdominals-Twisting Sit-ups, Leg Raise (hanging from Chinning Bar), Barbell Twists

Shaping exercises and **high reps** of (12) prevailed; using **light** to **moderate** weights. The number of **sets** for these exercises remained the same as in the previous schedule mentioned. **Rest between sets was 45 seconds to 1.5 minutes.**

**Impeccable Exercise Form and Extreme Metaphysical Concentration
Was a Priority
Each and Every Work!**

The Japanese Counter-Split Body Blast System as noted employ's the use of multiple exercises (muscle bulking and shaping) on each separate muscle group plus many of the prevalent bodybuilding principles (such as, **flushing, peak contraction, heavy and light, super-sets and triple progression pyramids, etc.**) and a unique **6/12 Rep System** for MASS & SHAPE.

Richard said that for a while he was smashing through training barriers and making "phenomenal progress" with the **Japanese Counter-Split Body Blast System**. However as with any training program he said that he begin to experience **low level time factored training results** where it seemed like his body was on "**strike**" (**over-trained**) so he decided to take a "**7**" **day layoff from training**.

Refreshed after the "**7**" **layoff** he decided to create a **Stand-Out Training Strategy** (my 21st century wording) where he would train less frequently, but still boost his muscle gains in ratio to the amount of time he was going to be investing in his training. Thus the revolutionary **21 Day (Mass Up Cycle)** program was created.

21 Day (Mass Up Cycle) Program

Richard told me that he developed a dual **21 Day (Mass Up Cycle) Program** which consisted of a **3 x 3 x 3 Exercise System** and an aggressive **stealth mega-calorie diet**. I asked him to tell me more about the **3 x 3 x 3 Exercise System**. He said that it consisted of **3 separate and distinct workouts**, performed **3 times** within in a **3 week period**.

The purpose of the **3 x 3 x 3 Exercise System** is two-fold in that it builds strength and muscle by becoming proficient in the performance of specific exercise movements.

I took notes while Richard was talking and I'm glad I did not leave it to memory alone (it's been 36+ years since that conversation). As the saying goes; "The palest of ink is better than the best memory."

Richard said he performed an average of only **four exercises** each workout on a rotational schedule, **Monday, Wednesday and Friday**. He went on to say that the key to his method of training was to work the involved muscle by performing the greatest number of sets he could recuperate from prior to his next workout. Each set was done with maximum poundage's that corresponded to a particular multiple-rep scheme.

He went on to say that his **workout tempo** (rep speed) was of a **MEDIUM or MODERATE SPEED**, which was neither **SLO-MO INTENSITY** nor **RAPID-FIRE** (two opposite extremes in workout tempo). Richard would achieve a rhythm of performance in which there were **no pauses at any point in the reps, nor between the reps** (unless otherwise noted on certain exercises). It is this rhythm of performance that actually allows the muscles to **re-engage themselves** at every point in the rep. It might be said that the muscles coax themselves to work. Each rep was performed deliberately and 'rhythmically'...never 'haphazard' or 'jerky' nor with the assistance of any other muscles of the body.

With regard to **rest periods** between sets he said this would vary from five minutes, when using low reps and heavy weight, to a minimum of 45 to 75 seconds when using higher reps.

His workout ethic was to maintain a maximum concentration of mind on his training effort. For instance when he would begin a **Close-grip standing wall curl** he didn't think of just getting the weight from the thighs to the shoulders. He would see a mental picture of each ascending muscle fiber in his biceps engaging (or 'meshing' like gears in a race car) the next fiber, and so on until he visualized the entire biceps as one big muscular effort in operation. It is when all the muscle fibers work together, sharing the movement, the more perfectly the muscle will grow...and get stronger.

To avoid frustrating his training efforts he allowed for proper physical and mental recovery by **resting & relaxing** on **Tuesday, Thursday, Saturday** and **Sunday**. This kept his body and mind from becoming over-trained and allowed for exceptional Muscle Growth.

He felt that his workouts were highly adaptable to experimentation. If, for example, he came into Monday's workout in a negative frame of mind – perhaps through lack of rest or extreme muscle soreness from lactic acid accumulation – and felt that it would take away from his maximum concentration on a particular exercise (or the total workout as a whole) he would move the exercise or workout ahead to Tuesday.

This he said is known as the **24-hour float method**. If only one exercise was affected the Wednesday and Friday workouts remain the same. However, if the total workout on Monday would be moved up to Tuesday, and the Wednesday and Friday workouts moved to Thursday and Saturday respectively.

After briefly explaining his workout concepts to me, Richard then handed me a copy of his **3 x 3 x 3 Exercise System**.

Here is that exact training schedule (exercises, sets, reps etc.) he used, plus an **encapsulated** commentary on the **Exercise Mastery Techniques** he used on most (not all) exercises.

3 x 3 x 3 Exercise System

Monday

1, [Supine \(flat\) barbell bench press](#) – It is not necessary to fully describe the action of this universally popular and often illustrated pectoral and strength building exercise. Suffice it to say Richard realized that anatomical differences can influence the effect that this exercise or any exercise for that matter, will have on a person's musculature.

Experiences in the hard-core trenches of bodybuilding taught him personally that the best method of performing the Supine (flat) barbell bench press is to do it with a wide hand spacing (36-inches and out) and elbows back (towards the ears). He would lower the bar **s-l-o-w-l-y** to his neck, pause for two seconds at the neck and then quickly press the bar locking the elbows out hard at the top. (Sometimes he would only press the bar to 2/3's lockout).

In the [Supine \(flat\) barbell bench press](#) (sometimes he used dumbbells) he would do **one set each** of **15, 10, 8, 4** and **1 rep(s)**, then rests for 5 minutes. Next were **10 power sets** of **5 to 6 reps** each. When these were completed he would take another short rest and would finish up with **one set each** of **10, 15** and **20 post-fatigue reps**.

A change in training intensity was always necessary to create a new muscle response (and up his bench press power base). So, he would use what he called the **shock/rebound technique (SRT)** on the last couple of power sets.

(SRT) This technique required the use of two or three one-inch thick high-density sponge rubber pads.

The rubber pads were custom cut **19-inches long** to (cover) his 51.5-inch chest from the collar bone (clavicle) to the sternum, and **12-inches wide** in order to add protection to the extreme outer pectoral region.

Richard would then get into his favorite stone cold flat fighting position on the bench. A training partner would then position the rubber pads on his chest. Lying there, with a bench press bar that had 300 reasons to make (render and splatter) him into a piece of road kill...it won't say hello.

Richard introduces himself by lowering the bar a little more quickly than usual to the highest point on his chest and immediately gets a slight (note, only slight) rebound off the pads. This is not a travesty of the previously mentioned, bench press to the neck, and here is the reason why.

The rebounding of the bar off the pads allows the pectoral muscles to momentarily reset themselves for another effort on the upward stroke and therefore bypass the sticking point (such an action leads to an improvement in

power in the working pectoral muscles) he continues pressing the weight to a lockout position. This completes one rep.

He would do this for 5 more reps (then) re-rack the bar (proclaiming it's fate as a lonely and stupid beaten piece of iron). This completed one power set using the shock/rebound technique. After a short rest-pause Richard did one more power set as just described. It is important to note that Richard's buttocks remained in contact with the bench surface at all times during the set.

The **shock/rebound technique** is excellent when a person has to lift alone. (This spectacular effective power leverage enhancement method) allows for a slight increase in poundage than would normally be used.

The **shock/rebound technique** mimics the assistance a spotter (training partner) gives during a controlled forced reps protocol.

Yet, another way to use rubber pads as a **shock/rebound technique** in the Supine (flat) bench press is to place two or three custom cut pads each on top of two stacks of 2" x 12" by 3' long wooden planks.

The (stack(s) are arranged, one on each side of the bench to accommodate for a particular range of measured movement in the bench press stroke).

Now it's just now a matter of lowering the bar down (in a controlled decent) so that the bottom edge of the barbell plate(s) touch the rubber surfaces in (causing a counter reverse velocity of energetic momentum) rebound effect just before the bar normally makes contact high on the chest. (You could also refer to this as... a power bump up...or force assistance 'positive blast').

The **shock/rebound technique (SRT)** has an unlimited potential for other exercises as well. The **Straight arm barbell pull-over** is one such exercise and is illustrated here.

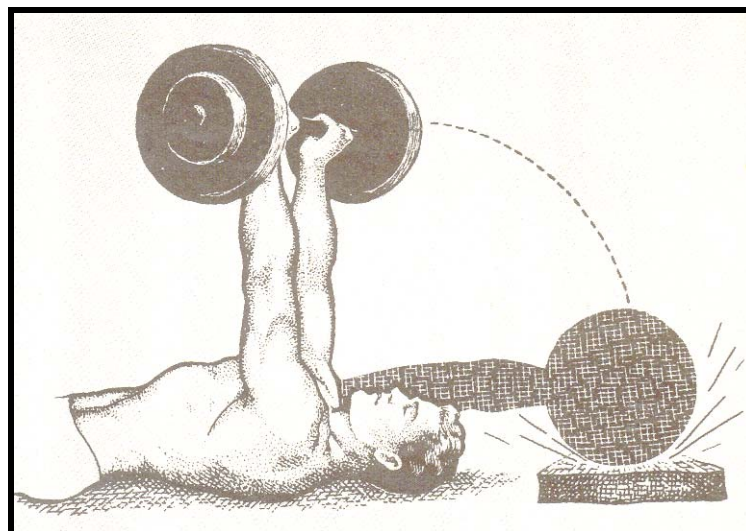

2. **Leg press** – Richard was prejudiced toward this leg exercise because he felt that when it was performed for high repetitions on a vertical Leg Press machine, it was superior to bodybuilding purposes, to say squatting with a barbell. Richard said in his personal opinion that there are **five** immediate and obvious advantages that the Leg Press has over other thigh-bombing exercises, such as squatting with a barbell.

First, there was no oppressive weight on the shoulders causing a spine compression. This will allow for maximum freedom of breathing and oxygen saturation which is necessary for increased rib cage circumference and respiratory and cardiovascular benefits.

Second, with no effect of spine compression, there is a corresponding marked decrease in the anatomical strain on the lumbo-sacral region.

Third, little concern is needed regarding balance, because the weight is within the center of gravity and this gives the option or freedom to explore the outer limits of physical strength safely.

Fourth, the Leg Press is a mechanically controlled movement that allows for stress where it needs to be such as the adductors of the inner thighs or the vastus lateralis of the outer thigh. Richard, for example, would space his feet **18 to 24 inches apart** on the footplate and **angle them out at about 45 degrees** or slightly more. From this extended position he would take in two or three big gulps of air and slowly lower the weight, bringing the knees wide and outward to the sides of the body. This was impacting on the inner thighs to say the least.

Initially I agreed with Richard up to this point and thoroughly understood what he was saying. However in defense of the Barbell back squat I mentioned to him that my bodybuilding mentors Donne Hale, Chuck Sipes and Peary Rader had collectively taught me a couple of important things.

No. 1

“Barbell back squats are the key to freedom from a thin man’s body.”

No. 2

“Barbell back squat when done with plenty of deep breathing and high reps is the **ULTRA-ANABOLIC “TRIGGER”** (my 21st century “buzz words”) for stepping over the boundaries of muscle growth.”

(I invite you to read about my experiences with the Barbell back squat on the home page of my website: www.dennisbweis.com).

I then asked Richard what he thought the fifth advantage of the Leg Press was...Richard was candidly honest with me and said,

Fifth, “I just prefer the Leg Press, because it’s easy!”

Richard and I concluded our friendly discussion on that note and then he revealed his Leg Press routine.

He said he would do **one set each of 30, 20, 15 and 10 maxi-pump reps**, after which he did **10 hard work sets of 15 reps** each.

On the **10 hard work sets** in particular he would use a **Five “up” and Five “down”** strategy **where** he would **“up”** the poundage for each of the first five sets and then **“down”** on the remaining five.

He finished off his leg press program with two quick **pump-out sets of 20 and 30 reps**. The last two pump sets for this and other exercises were done with light weights and helped to relieve the congestion of the muscles and restore normal circulation. This hastened recuperation and muscle growth.

Richard revealed one of his **SECRETS** about leg training. He said **“If you wish to shape your legs still further, you won’t find a more effective or enjoyable method than riding a racing bicycle. Rent, borrow or buy one and race it in sprints of five to ten minutes, as if doing sets, and you will improve contour, shape and definition of your entire leg musculature, considerably.” “Racing cyclists always have great legs.”**

My bodybuilding hero, Chuck Sipes, a great champion of yesteryear, had told me basically the same thing, about the value of biking short race distances as a means of creating extra muscle tonus, cuts and that fibrous thick, veiny look.

3. [Lat machine pull-down](#) – Richard performed this exercise using either a conventional straight and/or angled Lat- bar.

Richard began this exercise by first taking a wide enough hand spacing (palms forward) on the bar so that his forearms were never parallel during the movement. He took a **“false grip”** (thumbs wrapped over the bar rather than under) and always makes sure that the bar was positioned high in the palm of his hand (near the base of the meaty part of the thumb).

He would then take the path of most resistance by first **pulling his shoulders down**. Then he began the actual pulling motion with his elbows (his hands only act as hooks in an extension of himself to the bar), making sure that his arms rotated out to the sides (with **the elbows pointing down and to the rear**). Just these actions alone will stimulate more lat involvement and minimize biceps and forearms action.

As the bar touched the base of his neck he would try desperately to touch his elbows at an imaginary point behind his back. This action must be done without hunching over and, if done correctly, the shoulder blades will rotate inward. Richard imagined himself squeezing a tennis ball between them. This is the feeling he wanted to achieve for maximum contraction of his lats.

Slowly he extended his arms back to the starting position (**he hardly ever extended his arms to a fully straight position**) at which point he leaned forward somewhat so that he could get his shoulders into a semi dislocated state (by moving the shoulder joint up) and **s-t-r-e-t-c-h** the scapulae attachments outward for maximum back width.

For the sake of variety and due to the number of high-volume sets that he did, he would, at times, do lat pull-downs so that the bar touched the chest below the sternal (low) pectorals. On these he would **arch his back and lean backward 30 degrees or so from vertical** as the bar touches the chest. He would also at times take a narrow hand spacing of eight to twelve inches on the dorsi bar, using a supinated (palms up, curl) grip. This variation of the pull-down seemed to work well and involved the lats in a different way. It was a favorite of Sergio Oliva and other top bodybuilders of that era. The particular action of this lat pull-down to just below the low pectoral line requires that the arms pull all the way in to the sides of the body.

The aim of these or any other lat exercises was to first pull exclusively with pure lat action alone before involving the biceps by bending the arms. To up the percentage of his lat involvement,

Richard would always chalk his hands prior to gripping the bar, and use power wrist straps to help minimize biceps involvement.

✓ **A Recap!**

- **Be sure your feet are locked behind you.**
- **Back must be arched.**
- **Elbows pointed down and to the rear.**
- **Never extend arms to the fully straight position.**
- **Concentrate on moving the shoulder joint up and down**
- **If the shoulder joint stays in one place, most of the work shifts to the arms.**

Richard bombed his lats with **Lat machine pull-downs** (using a straight dorsi-bar) by opening with **one set each of 25, 20, 15, 12 and 10 maxi-pump reps**. These were followed up with a **12-set blitz of 10 reps** each. He then finished off with a **pump-out set of 15 to 25 reps**.

Pro Tip #1: Lat-bars which have horizontal grip handles also work well for developing sweeping lats.

21st Century Pro Tip #2: For a more complete scapulae attachment rotation use a Lat- bar that allows you to position the little fingers higher than the thumbs. The only bar that I know of that meets this criteria is the

Upside Down Lat Pull Down Bar which Larry Scott, the first IFBB Mr. Olympia, sells commercially on his web site (www.biophase.com).

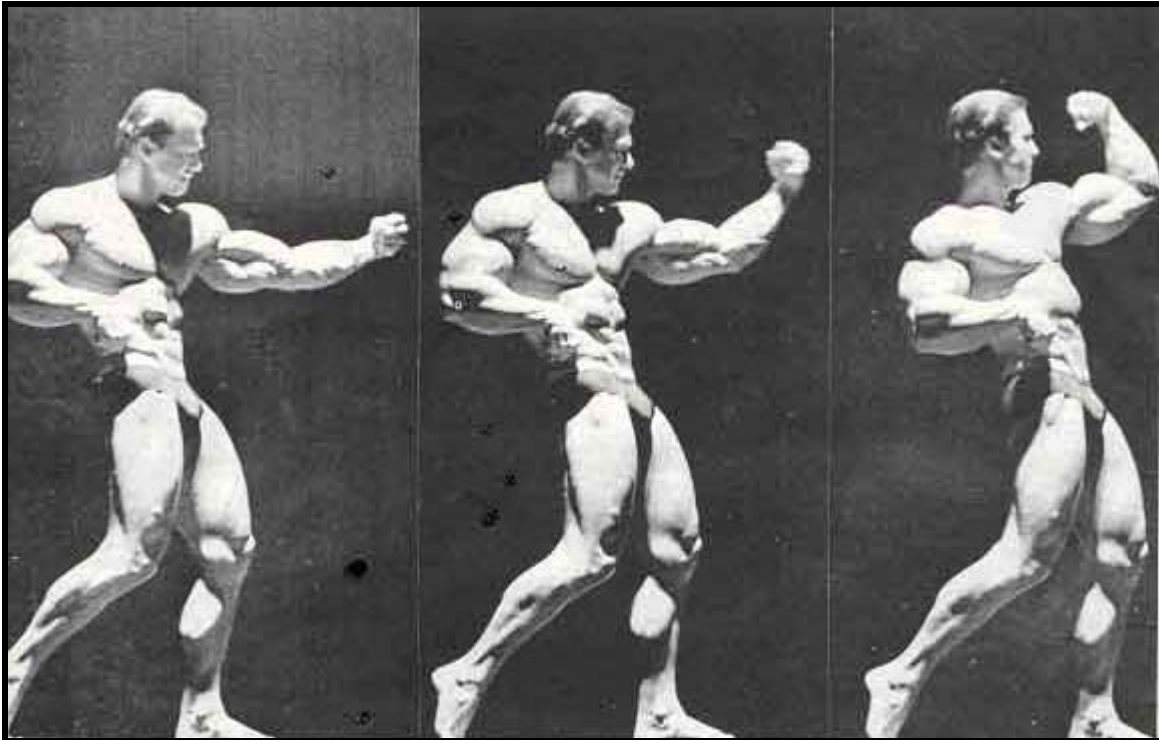

The first IFBB Mr. Olympia Larry D. Scott guest posing in the late 1960's

Wednesday

1. [Barbell press behind neck](#) – The way in which Richard described this exercise had me quite curious because I had never heard of it being performed in this manner.

He sat on the floor with his legs outstretched and his back braced securely against the foot of a stationary flat exercise bench. He readied himself by rotating and pulling his shoulders back as if standing at attention. This subtle move helps to eliminate the shoulder pain usually associated with this exercise.

He was now ready for his training partner to position the heavily loaded bar correctly in his hands. The correct hand placement is achieved when his forearms are perpendicular to the upper arms (biceps) when the bar is being pressed off the back of his traps. His elbows were kept directly under his hands (knuckles face ceiling), and pointing out to the sides and down.

From this position he took a couple of deep breaths. Holding the second breath, he began pressing the barbell to an arm-extended position. At two-thirds of the way to lockout he forcefully expels the air from his lungs.

At the extended or arms overhead position (sometimes he would hold the barbell here for a count of six) he will inhale a deep breath of air and hold it. He then lowered the bar back down to the base of the neck, exhaling air while doing so. Breathe in again. This is called “**double oxygen**” saturation. The bar touches; the base of the neck, in a feather-like fashion and the next rep begins. Occasionally he pressed the barbell only four to six inches above his head rather than going to complete lockout.

He began by performing one set each of **15, 10 and 8 repetitions** and then, after a rest, he got into the serious muscle growth by attacking his delts with **10 brutally hard power sets of 6 full reps** each, finishing up with a final **blitz set of 25 lightweight reps**.

2. [Barbell shoulder shrug](#) – On this particular exercise Richard, by the strength of his trapezius muscles alone moved mega poundage by raising his shoulders in a very direct up-and-down shrugging motion, trying like mad to touch his traps to his ears while at the same time extending his head backward as far as possible. He then squeezed and tenses his traps for all they were worth.

He was always very conscious not to rotate the shoulder joint, for this would take away from the very direct trapezius stimulation he is achieving with the straight up-and-down motion.

He always chalked his hands prior to each set just to make sure that his vice-like grip on the bar never gives out before the traps become fully pumped.

Sometimes using the magnesium carbonate chalk wasn't enough, and he'd use training straps for extra holding power.

There were training sessions where he grasped a heavy dumbbell in each hand and then positioned himself by sitting lengthwise on a flat bench with legs outstretched. Seated, holding the dumbbells with a neutral hand position (palms facing and parallel to each other) with the arms hanging straight down and in line with the shoulders, he was able to perform the purest shrugging action known. The arms were kept perfectly straight during the movement, and thus biceps action was kept to an absolute minimum. With the dumbbells hanging as they are, the resistance is now in the center of gravity instead of in front of it when using the barbell.

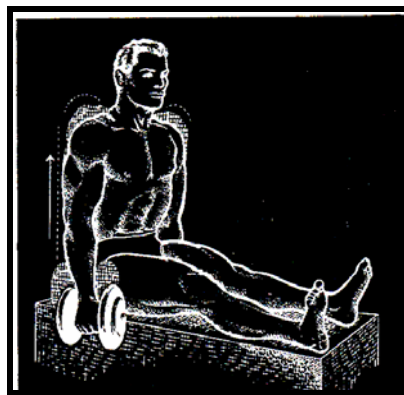

Seated Dumbbell shrugs

The seated shrug eliminates those little knee kicks (especially if the legs are outstretched on the bench) that normally occur during the standing barbell shrugs towards the end of a fatiguing set.

He performed **one pre-fatigue set each of 20 and 15 reps** then it was on to **8 sets of 10 to 12 muscle-searing reps**, finishing off with a lightweight **flush set of 15 to 20 reps**.

Pro Tip #1: Sometimes Richard tilted his head towards his chest (which he said isolated his traps even more) while going for a maximum squeeze & contraction at the top of the shrug movement.

Pro Tip #2: A cambered bench press bar (with the cambered portion of the bar facing down) positioned under a flat exercise bench is another option for performing shrugs.

3. ***Machine leg extension** – To reap the benefits of this exercise the quadriceps muscle must be fully contracted throughout the entire range of motion. With this in mind Richard would sit with his back arched and do this exercise very slowly and smoothly to prevent throwing or jerking the weight (which can cause injury) up. At the extended position of this exercise, when the quadriceps were fully contracted he would pause for two seconds on every rep.

He would then begin lowering the weight, even more slowly than he raised it. Generally he tried to lower it 2 times slower than he raised it. Richard stated that not all exercises were suitable for the “pause” method of performance.

He said that **Barbell back squats**, **Bench presses**, and the **Barbell press overhead**, for example, all involve a lockout at which point the weight is being supported by the bones.

Therefore the only select exercises suitable are ones in which bone support lockout does not occur such as **Leg extensions**, **Leg curls**, **Chest Machines** (Hammer Strength etc.), **Triceps pushdowns**, **Barbell high pulls**, **Dumbbell lateral raises**, **Barbell bent-over rowing**, **Pull-ups**, **Heel raises** (seated and standing), and **inverted or gravity boot sit-ups** (these are especially effective).

Richard said one of his “little tricks” in the Leg extension was to keep the toes pointed in (towards the shins) all the way through the movement. The particular machine that Richard used didn’t have a seat back so he would often lay back on the machine while doing the movement and thus recruit an even greater tension on his quadriceps.

Richard began the **Leg extensions** with a **set of 25 reps**, then **20 reps** followed by **6 sets of 15 reps** each, and then a **pump set of 20 and one of 30 reps**.

Pro Tip: Often times Richard would push on the seat with his hands, while raising his glutes off it 6 inches or so. His legs were facing downward at almost 45 degrees. He termed this as an incline leg extension.

4. ***Machine leg curl** – Lying prone on the machine, with his upper body and legs on the same plane, he would bend the legs and try to touch his heels to his glutes.

Sometimes he flexed his feet towards his shins through the positive and negative phases of the movement. Yet, at other times, he extended his feet in the opposite direction because he felt this effect in the soleus muscle of the calf strongly. To Richard, this created dual muscle stimulus in the hamstrings and the calves all in one exercise.

Being the instinctive bodybuilder that he was he would at times, rather than just lying prone on the machine, support his upper body on his elbows or completely with his arms locked so all the tension would be on the leg biceps.

On this exercise **one set each of 30, 20 and 15 reps**, then **6 sets of 10 to 12 reps** were performed, followed by a **final 20-to-30-rep set**. Richard said that when this exercise is executed in a flowing full contraction-and-extension manner, it is to the hamstrings what the barbell curl is to the biceps.

Pro Tip: Richard adducted (turned) his feet inward to stress inner hams on some sets and on others abducts or rotated them outward to hit the outer hamstrings.

***A Professional (plate-loaded) Leg Extension/Leg Curl Machine was used for exercises #3 & #4 (above).**

Friday

1. **Neck extension and flexion** – The exercises for this muscle group were of manual type resistance, performed with the help of a training partner. Anterior flexion (front of the neck), posterior extension (back of the neck) and lateral contraction (for the sides of the neck) were performed for a combined **10 sets of 20 reps each.**

It is interesting to notice that bodybuilders such as Richard, back in the 1960's almost always included some type of exercise for the neck, unlike many of the bodybuilders of today.

2. **Supine close-grip triceps press** – This exercise is performed on a flat position exercise bench, while using an E-Z-curl bar. Lying on the bench Richard would take a close, thumbs-free, hands facing inward, grip on the narrowest bends of the cambered bar. With the arms fully extended over the chest then it was just a matter of lowering the bar to his forehead, nose or neck (depending on the elbow orientation) and then with a powerful contraction of his triceps, press the bar back to near lockout.

Some times his elbows are positioned back at approximately 45 degrees past horizontal. With elbow flexion the bar is lowered so that it makes contact with the surface of the flat bench behind the head. Again with a powerful contraction from his triceps the forearms are then extended to near lockout overhead (not over the chest), which was in line with the shoulders. Richard picked up this unique triceps extension variation (Lying Barbell Kickback) from Ed Yarick, a trainer of three Mr. America's years ago.

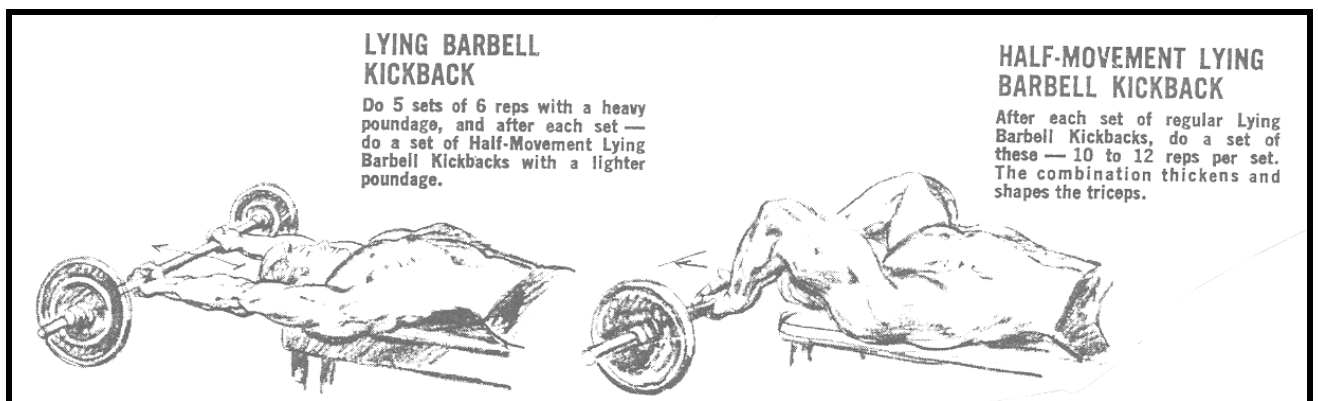

One set each of 20, 15 and 10, 6, 3 and 1 rep(s) were completed to warm-up the triceps thoroughly. This was followed up by **11 sets of 5 or 6 power reps** and then he finished off with a **20-rep pump set.**

The above described triceps extension is just one of four variations that Richard used throughout his bodybuilding career to force swift gains in size and strength. The other three variations included: The “**Atomic**” **Triceps Program,**

Supine “Rebound” Triceps Press, and the Standing “Curl-Grip” Triceps Press.

Here’s a brief overview of each of the “3” variations:

The “Atomic” Triceps Program

This is a shock blast program consisted of combining two exercises within the same set. The exercise of choice was the **Bent arm barbell pullover and triceps press** (E-Z-curl bar),

He would do the **Bent arm barbell pullover and triceps press** in the following manner: An adjustable sit-up (abdominal) board was set at a 30-degree angle, with a barbell on the floor directly at the lower end of it. The barbell is loaded to 40% of his 10 rep maximum in the **Supine close-grip triceps extension**.

While lying in a declined position on the bench Richard would reach back and grasp the bar (ref: Supine close-grip triceps press) and with the arms bent. He would then pull the bar in a semi-circle to the upper pectoral region, and with a brief pause, contract the triceps and extend the forearms up to lockout in strict form, lower the bar to the chest by elbow flexion, and return it to the floor. This was the completion of the first rep with fourteen more to go in this **first set**.

For the **second set**, the bar was loaded to 60% of a 10 rep maximum and 8 reps were performed. Then there was a **third set** of 8 reps, a **forth set** of 6 reps, then a **fifth set** for a triple and finally a **sixth set** where a limit single rep is performed. Richard would rest 3-5 minutes between the first and fifth sets. Upon completion of the sixth set, a ten-minute rest was taken while he massaged the triceps and saved his energy for the heavy work to follow.

The bar was then loaded to 1 ¼ times the weight that was used for single rep on the sixth set. Hypothetically if 100-pounds were performed for a single rep then the bar was loaded to 125-pounds. The bar is then pulled to the upper chest region, pressed to full extension over the chest. Now instead of lowering the bar all the way down to the chest as was previously done the bar is only lowered six to eight inches, then driven back to lock-out. This is repeated for eight reps.

The bar is next loaded with 25% more weight (using the hypothetical example above, the bar is now 150-pounds). Seven to ten sets of 6 reps in the measured movement (six to eight inches) **Close-grip triceps extension** is the order of the day (Richard would perform a total of 20-30 sets).

To finish off this routine a post-fatigue set of 25-30 consecutive reps are done to bring in an extra supply of blood to the triceps, for the recuperative processes of growth and repair, and to further accelerate recovery. Rest-pauses of 3-5

minutes was the norm and only one pullover was performed (first rep only) for each set of the measured movement **Close-grip triceps extension**.

Enormous poundage can be used in these short movements with the indirect effect being that a bodybuilder is able to use heavier poundage in the **regular Close-grip triceps extension**.

Supine “Shock/Rebound” Triceps Press

Load up an E-Z-curl bar with the largest diameter iron barbell plates possible. Place two or three one inch thick high-density sponge rubber pads under the barbell plates.

Now lie down on the floor (on a mat) **not a bench**, on your back with the bar positioned behind your head at semi arms length. Reach back and take a close-grip on the bar. Next pull the bar in a semi-circle over onto the chest and do a bench press motion to the lockout position.

Start the supine “shock/rebound triceps press by lowering (only the forearms move and they should not waiver or fish tale) the bar just back of the head, fairly fast, so that the barbell plates bounce off the rubber pads. Using the triceps begin extending the forearms with this bounce, driving the bar to arms length. It is the bounce that starts the weight upward ever so slightly and relieves the elbows of some of the tension momentarily. Continue doing a pre-determined number of reps in the manner described for several sets.

Standing Curl-Grip Triceps Press

Using a straight bar, take the same grip that you use for the Standing barbell curl. This will keep the strain off the elbows. At first this grip may feel awkward and you will feel like the bar is going to slip out of your hands, but after time, you will become accustom to it. You may want to use a “hook” grip where you wrap the two forefingers of each hand around the first joint of the thumb. This will seem uncomfortable on the thumbs at first, but you will become accustomed to this in a short time.

Richard would begin this exercise with both arms held above his head, elbows completely locked. From the overhead position the bar was only lowered until the forearms reached a parallel position. Without any pause what-so-ever Richard smoothly extended his forearms back to the fully locked elbow position, tightly squeezing and contracting his triceps muscles as hard as possible.

3. The Anton Curl – This exercise, popularized by “Big” Bill Anton, 13th man in the world to bench press 400, is best described as a Close-grip standing wall curl. Richard used this exercise because it tests the strength and power in his biceps like no other exercise. He would begin by grasping a loaded straight bar with a shoulder width hand spacing.

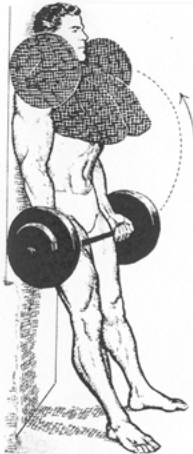

Anton Curls

He then leaned back against a wall (a stationary post or door jamb is much better) so that his back was flat against it for support. His legs were straight with his feet slightly forward from his body (approximately 18") with the barbell held at arms' length, resting against the front of his thighs. He kept the elbows well behind the plane of his body with the insides of his biceps touching his rib cage.

From here he curled the barbell (which is brushing the front of the body all the way up) to just below the low pectoral line. This action worked both the inner and lateral heads of his biceps.

At other times he curled the barbell in to his neck. In doing so his elbows moved forward and up which means that some deltoid action is taking place – not enough, however, to detract from the maximum peak squeezing and tensing effect he is able to accomplish on the biceps in this position. He then contracted the biceps muscles for a full two counts on each and every rep.

He used the same sets and reps as in the triceps extension exercise. One set each of 20, 15 and 10, 6, 3 and 1 rep(s) were completed and this was followed up by 11 sets of 5 or 6 power reps and finishes off with a 20-rep pump set.

Pro Tip #1: During some workouts, at the conclusion of the final rep of a power set, Richard would step away from the door jamb and cheat curl the weight up in the positive phase and lower in the negative style for 15 or so seconds, for an additional 2 or 3 rep(s).

Pro Tip #2: Sometimes he would do what is called Regular Sets, Plus Fast Doubles: This was done on his last power rep set. Example: Close-grip standing wall curl-when he completed his last power set and repetition, he would set the barbell down. He rested about 3-10 seconds and did two more repetitions, rested and did two more additional reps, rested and completed a final two reps.

Here's a Standing Barbell Wall Curl chart that Richard used from time to time as a reference to assess his biceps strength.

BARBELL WALL CURL

BODYWEIGHT CLASS	FAIR	GOOD	EXCELLENT
Bantamweight Up to 123 Lbs.	70	95	110
Featherweight Up to 132 Lbs.	80	95	110
Lightweight Up to 148 Lbs.	90	105	120
Middleweight Up to 165 Lbs.	100	115	130
Light-heavy Up to 181 Lbs.	110	125	140
Middle-heavy Up to 198 Lbs.	125	140	155
Heavyweight unlimited	140	155	170

4. **Back hinge deadlift** – On this “stand out” spinal erector muscle developer exercise Richard used an Olympic barbell which he centered on the end of a stable low flat exercise bench (or sturdy wooden box). Next he would stand at the exact end of the bench. He then leaned forward from his hips, pushing them rearward. Then with knuckles forward (false grip) took a wide hand placement (outside of shoulder width) on the bar. With the knees in a locked position (if his hamstrings were somewhat tight he would use a soft knee lock), arms locked straight at the elbow joints.

Simultaneously he contracted the muscles of his hamstrings, buttocks and lower back as he slowly stood up (pushing his hips forward) to a vertical position at which point he rotated his shoulders back and thrusts his chest out. While keeping a slight arch in the lower spine he would begin the next rep leaning forward, lowering the bar until his upper torso was at least parallel to the flat bench surface.

If his spine position began to be compromised (or rounded) he would stop the downward movement at that point (usually around the mid shin area). Most generally though he would make an effort to lower the bar to the feet so that it just touches them.

At first glance this famous lower back exercise (which Richard learned about from bodybuilding historian Charles A. Smith) would appear to be a version of the Stiff-legged deadlift while standing on a bench but there is a certain subtle technique that makes it slightly different.

As Richard would begin to pull the weight he didn't ALLOW THE BAR TO HANG AWAY FROM THE BODY. HE KEPT IT (the bar) IN CONTACT WITH HIS LEGS ALL THE WAY TO UPRIGHT POSTION. Richard said that even comparatively light weights in this exercise build up POWER. A bodybuilder who can use a 150 pounds in the manner described is indeed powerful.

One other unique deadlift variation he implemented in other workouts aside from the special 21 day program espoused in this e-report was what he called **snatch-grip deadlifts** (a favorite of the late Steve Reeves). He would load up a seven foot Olympic bar with a few hundred pounds of heavy iron. Now this is where it gets interesting. Instead of grabbing the bar he would instead grasp the lip edge of the 45-pound plates with only his fingers and do the deadlifts in this manner. (A picture is worth a "thousand words" as it applies to the two exercises mentioned. Here is a photo showing the late Steve Reeves of Hercules fame doing **Snatch-grip deadlifts** and an illustration of the **Back hinge deadlift**)

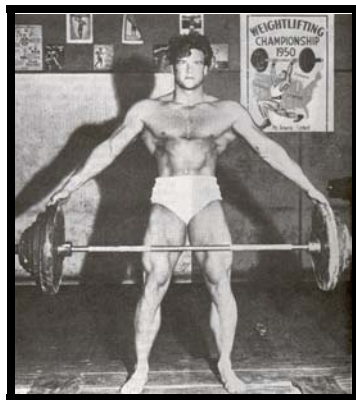

Snatch-grip deadlift



Back hinge deadlift

With regard to the **Back hinge deadlift** Richard would do **one set each** of **20, 12, 8, 4, 1, 5, 10** and **15 reps** within any of the deadlift executions mentioned

5. **Donkey calf raise** – Richard would do this exercise on a Rheo H. Blair wood calf block.

The block is six inches in height and allows for non interference of the stretching at the bottom of the movement. The ultimate in stretching is achieved because the block has a rounded edge and is completely covered with a 1/2" thick rubber foam and a 1/8" thick piece of ribbed rubber on top of that. This allows a bodybuilder to really grab hold of the surface with the toes and balls of the feet (without pain) and go into the calf-building super stretch without any fear of slipping off the block.

Richard used one of two basic foot positions on the Blair calf block.

Position #1: (toes 12 to 16" apart with heels 4" apart) develops the inner calf, but only coming up on the ball of the foot and big toe.

Position #2: (toes 8 to 12” apart with the heels much, much wider, as if assuming a pigeon-toed stance) it is most important to come up on the lateral or outer edge of the foot for maximum outer-calf stress. Richard assumed either one of these two positions without his shoes on.

(Personally I feel that it is best to wear shoes, which offer a high degree of traction and have a very thin, flexible sole. The best shoes that I have found that serve this purpose are the low-top Otomix. For Information visit: www.otomix.com).

He then bent over until his upper torso was perpendicular to the floor and supported himself by placing his elbows on another bench or on a horizontal bar which is about waist height and 30 to 36” away from the Blair calf block. Now it was just a matter of bending his knees and dropping down (to protect his lower back), allowing his workout partner to mount him in a position directly over his hips.

He locked his knee joints and begins with a set of **30 maxi-pump reps**. Richard rested for a minute between sets then continued his journey into the pain zone by doing **one set each of 20, 12, 15, 20 and 30 maxi-pump reps**.

Sometimes he did what he termed a standing donkey calf raise where a workout partner sits astride his shoulders. He felt that this particular variation allowed for a more direct approach to the stretch at the bottom of the movement. Either one of these two exercises become especially intense if the workout partner holding a pair of 40-pound (plus) dumbbells in his hands.

If a workout partner was not available for the donkey calf raises, he improvised by doing them on a vertical leg press machine, or if things come to the worse, he attached a very heavy dumbbell or some cast iron dumbbell plates to a dip belt and would go from there.

Richard would work his calves to the point where their ability to resist the growth impulse would be used up and they would have to respond with new growth.

Pro Tip #1: The Rheo H. Blair calf block was a revolutionary new design in calf training equipment back in the 1960’s but unfortunately it is no longer available. However a company named ARC International has developed the CALF MASTER block.

The CALF MASTER block has a bio-mechanically designed footplate which is shaped like an arc that follows the contour of the foot. The unique footplate (curve/arc) on this piece of equipment is a mirror image in design of the Blair calf block except that it is made of metal.

The CALF MASTER comes in three models. I suggest you call ARC International at 1.877.272.1468 and learn more about the revolutionary CALF MASTER.

Another calf training innovation that I have recently become aware of is Roger Stewart's "EXTREME" CALF MACHINE.

This machine is actually a calf block made of aluminum but with one important and unique feature. It has a patented pivoting footplate which adds an important new dimension for expanding and upgrading calf training as we know it. The pivoting footplate extends the exercise motion and thereby creates the ultimate stretch and contraction of the calves.

I own both of the calf units mentioned and I find that I get the utmost calf isolation, stimulation and growth using Roger Stewart's "EXTREME" CALF MACHINE. For more information e-mail Roger at B1Fit@bellsouth.net or call 1.866.468.3688.



Roger Stewart's
"EXTREME"
CALF MACHINE

IF YOU ARE TIRED OF SMALL OR OUT OF PROPORTION CALVES, THIS IS THE MACHINE FOR YOU! ROGER STEWART'S EXTREME CALF MACHINE, WITH PATENTED PIVOTING PEDAL, GIVES CALVES GREATER STRETCH AND CONTRACTION THAN JUST A REGULAR FLAT PLATFORM, WHICH IS THE KEY TO OUTSTANDING CALF DEVELOPMENT IN A SHORT TIME.

****DESIGNED, TESTED AND PATENTED BY ROGER STEWART****
VOTED BEST CALVES IN THE WORLD!!



BLACK /
WHITE

STEWART
 INNOVATIONS, INC.
 P.O. Box 1024
 Windermere, FL 34786

B1Fit@bellsouth.net

ONE OF A KIND
 PATENT NO. D460, S07

1-866-INVENT-8

HOME,
 OFFICE
 OR GYM

INTRODUCTORY SPECIAL \$49.95

EASY TO USE
 LIGHTWEIGHT
 PORTABLE

PATENTED PIVOTING PEDAL FOR MAXIMUM STRETCH
 STRONG AND DURABLE
 NON-SKID SURFACE

HELPS INCREASE THE FLOW OF BLOOD AND OXYGEN THROUGHOUT THE CALVES

STANDING CALF RAISE, SEATED CALF RAISE, DONKEY CALF RAISE, SINGLE CALF RAISE ALL IN ONE

HELPS DEVELOP, SHAPE, STRETCH AND TONE

Pro Tip #2: Between sets of the donkey calf raises, he did **Alternating Standing heel raises** using just his own bodyweight. This was done while still maintaining good form.

The alternating style involves a transition of going from two to one legged **Standing heel raises** as follows: With both legs absolutely locked at the knee joints he s-l-o-w-l-y lowered both of his heels down to the maximum negative stretch contraction position, actually trying to touch them to the floor. This was the starting point for beginning the set. From here and again with a s-l-o-w deliberate rep speed he raised his heels

through the positive muscle contraction phase, going up on the balls of his feet and finally shifting his weight distribution to the first three toes (big toe and next two) of each foot at the top of the peak contraction.

At this point he bent his left knee joint and shifted his weight distribution to the right leg, which was still maintaining a knee-lock position.

He then lowered s-l-o-w-l-y on the right leg through the complete negative stretch contraction, pauses for a one-second stretch and then rose back up through the positive muscle contraction phases.

He held this “peak contraction” with the right leg for a count of two and then bent his right knee joint and shifted his weight distribution to his left leg and locked this knee joint. He then proceeded to do the sequence in the manner described for the right leg again.

It is important to remember that, although only one leg at a time is being worked, both feet are gripping the ribbed rubber surface of the calf block, but with one leg bent and the other leg straight.

He did this in a smooth and rhythmical motion, rather than rapidly, for 50 maxi-pump reps. Doing this movement in between sets helps to maintain a muscle fatigue tension threshold for maximum gains.

Sometimes, if he didn't make it to the gym, he did a weightless workout for the legs (using just his own bodyweight), super-setting this exercise with the “Muscle Beach” Sissy squat for 10 nonstop supersets.

He did 20 to 30 maxi-pump reps on each set of the alternate one-legged donkey calf raises and 12 to 15 maxi-pump reps on the Sissy squat. For those of you who are not familiar with the “Muscle Beach” Sissy squat, I offer you this graphic illustration and brief description.



Body-Weight Only
“Muscle Beach” Sissy Squat
“The Ultimate Quad Pump-Out”

“Muscle Beach” Sissy Squat Technique

Stand in an upright vertical posture next to a stationary post, power rack or chair, etc. With a slight absence of knee lock, place your feet approximately 12 to 18 inches apart, with heels inward and toes rotated out laterally, just slightly. Vince Gironda says the feet should be 13” apart and the knees 17” wide.

To maintain a perfect balance in this “fire-bombing” quadriceps exercise, lightly grasp hold of the stationary post, etc. with one hand.

Now, with just your own bodyweight, rise up on your toes or, if you wish, place your heels on a 4” x 4” block of wood. Lean your upper torso backward (approximately 45 degrees from vertical) until you feel a maximum stretch contraction in the quads, especially just above the knees. Your upper torso and thighs will be in alignment with one another if you have done this correctly.

While maintaining this inclined, lying back position (you will basically be at a 45-degree angle to horizontal position), slowly lower your body by bending your knees, allowing them to thrust forward. Allow the upper torso and thighs to descend to where the shoulders are directly over the heels and beyond. Do not relax at this point. Keep continuous tension on the quads by doing a smooth direction reversal at the bottom of the negative stretch (approximately parallel to the floor) phase by straightening your quads and driving your hips forward till you are once again at the non-lock starting point. Remember, as you come up, to push off on your heels while pulling the front part of your foot up off the floor.

Begin the next rep immediately. With absolutely no pausing, continue until you have completed 12 to 15 maxi-pump reps in nonstop, nonlock style.

It is a very good idea to practice the “Muscle Beach” sissy squats with just your own bodyweight until it becomes a natural movement.

There is a saying, “Practice makes perfect.” I prefer to take it one step further and say, “Perfect practice makes perfect.” This makes sense because, if you practice the Sissy squat or any other exercise for that matter, using sloppy form, you will never develop a precision technique.

Once you have mastered a precision technique with your own bodyweight you can begin to use extra weight in the form of a cast iron plate or a dumbbell or dumbbells.

Of the three options, the loose plate is the easiest to accommodate because all you have to do is hold it securely against your chest with your

free hand while maintaining perfect balance with the other. Holding a barbell (as in a Front squat position) or holding dumbbells hanging at your sides does not allow for the degree of leaning back you achieved with your bodyweight alone.

The reason is that your balance is compromised because your hands are not free to assist you. This is a very minor obstacle to overcome. You can attach a 4-6 foot length of 1/2" rope securely around your waist (or tie it to the front of your lifting belt, directly in the center) then tie the other end of the rope at chest level to a stationary post.

This will free up your hands so that you can use the barbell or dumbbells, and at the same time allow you to maintain the proper inclined layback position – and with perfect balance.

Sometimes Richard not only super-setted this bodyweight-only quads exercise with calves, but from time to time he supersetts the Sissy squat (using a Roman chair exercise unit) with Duc leg presses on a vertical Leg press machine.

Cumulative Reps

As a side note the late Chuck Sipes (www.chucksipes.com) a former IFBB Mr. World, on the other hand, would take the supported bodyweight-only “Muscle Beach” Sissy squat to the outer limits of muscle stimulation by doing cumulative repetitions, finishing off with 20 maxi-pump reps.

The premise behind cumulative repetitions as Chuck preferred it was to do 1 rep in the Sissy squat, then walk 15 feet in one direction, return and do 2 reps...walk 15 feet and return again and do 3 reps, etc., etc., ‘till he simply couldn’t do another full set of the reps he had accumulated so far (in his case it was 20). The “walk” should only take 10 to 12 seconds. This then is” **Cumulative-Reps.**” For a more detailed account of “Cumulative-Reps” refer to the Addendum at the end of this e-report.

The bottom line is that if you want the ultimate in granite-hard quads, laced with deep cuts, then do as Richard Simons, Chuck Sipes and many of the west coast bodybuilding champions did and still do to this day – do Sissy squats!

Richard was into legwork in a big way – especially using the advanced superset technique just described. Sometimes he would superset “Muscle Beach” Sissy squats with Leg curls or use any one of the following combinations: Back squats with Front squats, Leg presses with Leg extensions, Leg presses with Leg curls (non-lock style), Leg extensions with Leg curls.

3 x 3 x 3 Exercise System-A QuickReview

Monday

Supine (flat) barbell bench press – Using a barbell (though sometimes he used dumbbells) he would do **one set each** of **15, 10, 8, 4** and **1 rep(s)**, then rests for 5 minutes. Next were **10 power sets** of **5 to 6 reps** each. When these were completed he would take another short rest and would finish up with **one set each** of **10, 15** and **20 post-fatigue reps**.

Leg press –He would do **one set each** of **30, 20, 15** and **10 maxi-pump reps**, after which he did **10 hard work sets** of **15 reps** each.

On these (ten hard work) sets in particular he would use a **Five “up”** and **Five “down”** strategy **where** he would **“up”** the poundage for each of the first five sets and then **“down”** on the remaining five.

He finished off his leg press program with two quick **pump-out sets** of **20** and **30 reps**. The last two pump sets for this and other exercises were done with light weights and helped to relieve the congestion of the muscles and restore normal circulation. This hastened recuperation and muscle growth.

Lat machine pull-down – Richard bombed his lats, doing **one set each** of **25, 20, 15, 12** and **10 maxi-pump reps**. These were followed up with a **12-set blitz** of **10 reps** each. He then finished off with a **pump-out set** of **15 to 25 reps**.

Wednesday

Barbell press behind neck – He began by performing one set each of **15, 10** and **8 repetitions** and then, after a rest, he got into the serious muscle growth by attacking his delts with **10 brutally hard power sets** of **6 full reps** each, finishing up with a final **blitz set** of **25 lightweight reps**.

Barbell shoulder shrug –He performed **one pre-fatigue set each** of **20** and **15 reps** then it was on to **8 sets** of **10 to 12 muscle-searing reps**, finishing off with a lightweight **flush set** of **15 to 20 reps**.

Machine leg extension – Richard began the **Leg extensions** with a **set** of **25 reps**, then **20 reps** followed by **6 sets** of **15 reps** each, and then a **pump set** of **20** and one of **30 reps**.

Machine leg curl – On this exercise **one set each** of **30, 20** and **15 reps**, then **6 sets** of **10 to 12 reps** were performed, followed by a **final 20-to-30-rep set**.

Friday

Neck extension and flexion –10 sets of 20 reps each.

Supine close-grip triceps press –One set each of 20, 15 and 10, 6, 3 and 1 rep(s) were completed to warm-up the triceps thoroughly. This was followed up by 11 sets of 5 or 6 power reps and then he finished off with a 20-rep pump set.

The Anton Curl –He used the same sets and reps as in the triceps extension exercise. One set each of 20, 15 and 10, 6, 3 and 1 rep(s) were completed and this was followed up by 11 sets of 5 or 6 power reps and finishes off with a 20-rep pump set.

Back hinge deadlift – He did one set each of 20, 12, 8, 4, 1, 5, 10 and 15 reps.

Donkey calf raise – He begins with a set of 30 maxi-pump reps. Richard rested for a minute between sets then continued his journey into the pain zone by doing one set each of 20, 12, 15, 20 and 30 maxi-pump reps.

Capsule Comments

As I mentioned at the beginning of this report Richard used a maximum poundage loading scheme (known as the **Kaizen Principle**. Charles Poliquin explains it in chapter 6 of his book **The Poliquin Principles**. Visit: www.charlespoliquin.net).

He used near perfect “**technique emphasis**” within each of the sets (weights were handled in strict fashion with no “**jerking**” or “**bouncing**” movements, the exception being the **shock/rebound technique** that he sometimes used in bench pressing (Monday workout).

Although I didn’t actually see of the exact workouts mentioned in this e-report I did have the opportunity of watching Richard work out on other occasions (**Donne Hales “Fitness and Figure Gym”** in Hialeah, Florida in 1966) and can testify to his use of maximum poundage and impeccable “technique-emphasis” on the exercises he was doing and have no reason to believe that he would do otherwise in any training program that he would embark upon.

Richard told me that an exercise is only effective as the effort you apply. The most effective ones he used in his **workouts** were movements he enjoyed doing rather than similar exercises he had a mental block against.

He said that some of the “**anabolic equalizer**” (my 21st century “buzz words”) exercises he used in this particular program may not be suitable for others, due to certain injuries that may make the exercise painful and limit progress. He suggested using other exercises that perform a similar action but allow you to make better, pain-free gains.

Richard went on to say that with the exception of legs and biceps work, he got the most benefit out of his exercises by doing them in the conventional “**set-rest-set**” fashion as opposed to perhaps doing them in “**set extension technique**” fashion (i.e. super-sets, tri-sets, negatives, etc.) and having to deal with a condition known to bodybuilders as “**pressure-pain.**”

Thinking back to this discussion on exercise I completely spaced asking Richard why there weren’t any abdominal (I observed his abs and to me they appeared firm and in proportion to the rest of his physique) or forearm exercises in this particular program.

The Stealth Mega-Calorie Diet

Supporting the huge energy requirements necessary for the “9” high-volume muscle pumping workouts required an aggressive stepped up increase in daily calories consumed.

Over a very short period of time Richard went from **5,000** (where he was consuming 200 grams of high quality protein, 600 grams of carbohydrates and 200 grams of fat) to **9,000** calories per day with about 1,560 of the calories (**390 grams**) being in the form of complete proteins. The carbohydrates and fats increased proportionately. A rough estimate reveals that 15% of his daily calories came from complete proteins, 45% from carbohydrates and a whopping 40% from dietary fat sources.

Richard clarified his **5,000** to **9,000** mega calorie concept by saying that he didn't just go from 5,000 to 9,000 overnight during the **21 Day (Mass Up Cycle)** but increased his calorie consumption in stages by a few hundred or so every day.

He did say that most male bodybuilders could meet most of their nutritional demands on **5,000-6,000** calories with a 1000 of those calories (**250 grams**) being in the form of quality dietary protein.

To meet the demands of consuming 390 grams of a high quality dietary protein per day, Richard said that he would chug down **6-9 quarts of milk**, (Richard remarked that **Reindeer milk** at 160 grams of protein to the quart and loaded with mega calories was a secret to the nutritional gain factor), **3 pounds of meat** (mostly hamburger and other cheaper cuts of meat to keep his grocery bill down), and plenty of **tuna, chicken, eggs, pasta, cheese, beans, unsalted peanuts, raisins, dates, figs, potatoes, yams** and **natural peanut butter** (in large amounts). He did as best he could to avoid foods high in salt, sugar and food additives.

To insure that the protein sources was properly assimilated he would drink **one quart of Papaya juice daily**.

It should be noted that Richard **didn't have** any **synchronistic mealtime strategies** (In other words he didn't plan each day's meals ahead of time) except to eat and drink whenever he felt the need throughout the day. He never allowed himself get very hungry and he would only eat till he was full **but not** stuffed or bloated.

He did clarify this in a bit more detail by saying that to get the big gains in size and power a bodybuilder should get used to eating 3 square meals and 2-5 snack meals (these are smaller liquid or solid meals consumed between breakfast, lunch, dinner and before retiring), every 1-3 hours, seven days per

week. To avoid missing any of these meals Richard kept his fridge and cupboards well stocked.

Of all the meals that Richard ate Breakfast was a special occasion and He always started the day with a breakfast of one of the following:

Whole Brown Rice – about five minutes before it's finished, add a half cup of raisins and a half cup of dairy cream, stirring it in. Serve with a liberal supply of cream, honey and wheat germ stirred through it.

Cooked Oatmeal – rather than combing water with the oats when cooking, make up the oatmeal with whole milk instead. About five minutes before this is finished add a half cup of diced dates, and a cup of cream. Serve as above, with cream, honey, tablespoon of safflower oil and wheat germ flakes stirred through it.

One early morning meal he especially enjoyed was what he called...

A Man's Breakfast

He would mix 1 cup of fresh squeezed orange juice with 1 tablespoon of brewer's yeast powder. Then he would have 3 ounces of Bob Hoffman's breakfast food with milk.

Next he took 1-1 ½ cupfuls of **Rheo H. Blair's** special "**Milk and Egg**" **protein powder** and mixed it (in a blender) with 16 ounces of whole milk (raw) and 16 ounces of whipping cream (preferable raw). He then added to this beverage some of Blair's special coconut flavoring. This protein drink made with "half-and-half" is delicious and tasty, especially if the milk and cream are VERY COLD!

He would sip a glassful (8 ounces) of this beverage over a period of 30 minutes while he prepared the rest of his breakfast. Richard said that sipping the protein drink as opposed to hurriedly "drinking" it avoided problems that could arise from pouring protein, 38-40 grams to the 8 ounce glassful, into the stomach too quickly.

He would then broil a 4-ounce lean beef patty which was to be eaten with the following:

Omelet Recipe

5 eggs, 2 cups of dry milk, 1/4th cup wheat germ flakes, milk if needed and a piece of American cheese (2' x 1" x 1").

Beat the eggs, blend in powdered milk and wheat germ flakes, and add a little bit of milk if needed. The egg mixture was then poured into a hot buttered omelet pan and fried as for a regular omelet, with the cheese broken into small pieces and mixed in or melted on top. Since he had a super hearty appetite he would include some whole-wheat toast to go along with this breakfast.

This breakfast alone has approximately 225+ big grams of quality protein and 2,000+ total calories.

As an added note, on the mornings when Richard didn't have the omelet for breakfast he would include from 4 to 6 raw eggs (fertile if possible) and a teaspoon or two of safflower oil into the blender drink concoction. For an extra boost in protein during the day he would have An 8 ounce glassful of this drink an hour prior to working out and an hour afterwards.

I was concerned about the amount of whipping cream Richard was consuming and gasped, "You mean you sipped over a quart of whipping cream a day without adding fat?" Richard said that the preferred liquid for mixing the Blair protein is "**half-and-half**" and for a good reason.

Nature seems to indicate that protein and fat should be taken in equal balance. Milk with 3% protein is balanced with an equal amount of fat, likewise for, eggs and meat, etc.

Richard explained that **Blair's Instant Protein is extracted from milk and eggs** without the normally occurring fat (both the eggs and milk were defatted in the processing). Whole milk is normally balanced by itself, so when the protein is mixed with milk the balance is thrown off. However, by mixing the protein with **half whole milk and half heavy whipping cream** some of the fat is restored that was previously removed during the processing.

Richard told me that he or anyone else is not actually consuming "**half-and-half**" per say. He went on to say that **Blair's Instant Protein** when mixed with "**half-and-half**" makes a "milk" drink which is equivalent to whole milk in the balance of protein and fat.

He did say that his physique looked a tad smooth during the 21 day mega-calorie diet so he generally kept his carbohydrate intake relatively low and made Rheo H. Blair's "low-carb" milk and egg protein the basis of his diet to hold onto some degree of overall body muscularity.

HOW TO USE BLAIR'S PROTEIN SUPPLEMENT

Richard determined that the key with a milk & egg protein supplement such as Blair's for all bodybuilding goals is **what you mix with it**. Sometimes he would forgo the use of whole milk and whipping cream and enjoyed mixing the protein with unsweetened grapefruit juice (not grape juice, because it is too high in sugar), fresh orange juice or carrot juice. Today a bodybuilder has the opportunity to mix a protein such as Blair's with a non-caloric (sugarless) non-cola bottled drink such as diet orange soda or Fresca.

He said there were other more specialized ways to use Blair's milk & egg protein supplement depending on one's body type and he offered the following "**3**" recipes:

For Maximum Definition and Fat Loss:

Substitute breakfast and lunch with a protein drink made of one-third cup Blair's milk & egg protein powder and 8 ounces water. Dinner should consist of meat and a salad.

For Muscle-Density Gains (for the underweight bodybuilder):

Mix one-third to one-half cup Blair's milk & egg protein powder and two eggs in 8 ounces of certified raw milk. Sip this slowly at 10:00 a.m. Have another liquid protein feeding at 4:00 p.m., and another one hour before retiring to bed. Breakfast, lunch and dinner should consist of meat, fish, fowl and protein-rich dairy products such as cottage cheese, cheese and eggs.

For A Gradual Muscularization of The Body:

Always have a protein drink with 2 ounces of certified raw cream, 6 ounces of water and one-third cup of Blair's milk & egg protein and one egg yolk, one hour before training. This drink will allow a bodybuilder to maintain optimum muscle size while on a low carbohydrate definition diet.

Many of the top bodybuilding champions (such as Gable Paul Boudreaux, Dave Draper, Vince Gironda, Don Richard Howorth, Larry Scott, Arnold Schwarzenegger and Frank Zane) of that day used to load up on the wildly popular and result-producing Blair "Milk & Egg" protein powder.



Visit: www.rheoblair.com.

Richards Vitamin/Mineral Regime

He also took in plenty of vitamins and minerals in supplement form throughout each day. This strengthened his body from the inside, feeding it the necessary minerals, nutrients, energy and bodybuilding materials it needed.

Richard took B Complex (3 times per day), 45 mgs. of Thiamine (Vitamin B1), 50,000 I.U. Vitamin A, 4,000-6,000 mgs. Vitamin C & Bioflavonoids, 800-1,000 I.U. Vitamin E, and 5 tablespoons of wheat germ oil.

The Transformation!

By following the **3 x 3 x 3 Exercise System** and **stepped up daily calorie consumption**, as outlined, Richard increased his bodyweight from 200 pounds to 225 pounds. This was a gain of **25 Pounds of in 21 Days**.

To my mind this mega-gain factor was startling but more than that it was not accomplished at the expense of an unattractive physique. I had the opportunity to see Richard only a week or so after his transformation and in my mind's eye he displayed decent muscular contours, pleasing lines and a symmetrical shape.

At a height of 6'2" Richard had some impressive body part measurements to go along with his muscle weight gain. His upper arms measured 18.5 inches, forearms (gooseneck) 15.5 inches, chest 51.5 inches, waist 34 inches, thighs 28.5 inches and calves 17.5 inches (calves were a lagging muscle group for Richard).

Richard told me that his primary goal was to one day weigh in at a **rock hard**, 255 pounds. To achieve this he said that he would have to get his bodyweight up to 300 pounds and then train and diet back down slowly to his goal of 255 pounds.

Richard cautioned that such increases should never be determined solely by what the scale revealed but rather how much muscular bulk the skeletal structure can additionally hold without losing any great degree of pleasing lines that give it shape.

He went on to say that gains such as **25 Pounds in 21 Days**, should never be acquired through inactivity and a voracious appetite. This kind of weight gain is useless and represents “dead weight” around the body. Plus it gives the appearance of a very awkward physique with an accompanying decrease in physical ability and efficiency of the individual.

Richard’s physique as near as I could tell personified an unusual combination of added muscular bulk coupled with an increase in strength and power. As the years past I lost track of Richard so I never did find out if he achieved his primary goal.

The Pros and Cons of Muscular Bulk Routines

Muscular bulk routines such as **25 Pounds in 21 Days** and many others have advantages and disadvantages and Richard discussed these me in explicit detail.

Advantages:

For the novice or beginner bodybuilder, especially, properly applied muscular bulk routines can be of great value; Such a program assists in reorganizing the efficiency of the metabolism so future gains come more readily; a heavy muscular bulk routine of training for the total body (as opposed to just training the upper body or lower body exclusively), combined with a very heavy but balanced diet and a great deal of rest and sleep increases the gain theory factor in a shorter period of time than certain other methods of training and eating. All in all the novice or beginner bodybuilder experiences a new self-confidence, and of course body part measurements, body weight, energy and maximum single effort lifts always go up during a muscular bulk phase.

For the intermediate and advanced bodybuilder the advantages are somewhat different. For these individuals muscular bulk routines are excellent for promoting better muscle structural integrity that had been previously unresponsive or neglected; pushing past a sticking point; putting on a few inches of muscle for an occasion of importance, be it a bodybuilding contest or even a high school class reunion. Another advantage of a muscular bulk routine is that it can be used to go up 10 to say 50 pounds, to see how you appear at a higher body weight; to see if your height and bone structure will accommodate such muscular increases.

The advantages of muscular bulk routines are obvious but there are a few disadvantages that sometimes attach themselves.

Disadvantages:

First and foremost by embarking on a natural retro-mass routine your grocery bill can't help but increase monetarily as opposed to what you were paying previously for the food items of your regular diet. A part of the success of a muscular bulk program is the principle of progressive eating wherein there is a very high calorie intake, fairly high intake of liquids, and a high intake of protein foods.

A classic example is a bodybuilder named **Bruce Randall**, who back in the 50's bulked up to a bodyweight of over 400 pounds (this was definitely on the other side huge back then) in an effort to break some of the strength records of the now, late, **Paul Anderson**. The following is a great evidence based before and after photo(s) of Bruce Randall...



Bruce Randall, New York City, is one man who bulked up to over 400 pounds and then, through careful dieting and regular training reduced his bodyweight to less than 200 pounds and showed amazing muscular definition as the picture on the left shows here. Note how smooth and bulky he looks in the other photo in which he weighed 403 pounds. These pictures make an interesting study, we think.

Bruce followed such extreme dietary measures as eating 7 pounds of meat and drinking 8 to 10 quarts of milk a day (between meals). At times his milk consumption reached 19 quarts a day! He would eat four meals a day which was unusual back then, but not by the standards of pro bodybuilders of the 21st century.

The amount of food he consumed per meal was what was mind boggling. For example, breakfast consisted of 2 quarts of milk, 1 ½ loaves of bread and 28 fried eggs. This was during a time when his bodyweight was around 340 pounds. Bruce's progressive eating scheme was a short term issue of just 21 days but in fact carried on for nearly 31 months.

His grocery bill when computed was \$80-\$100 per week, remember this was back in the 50's. Fortunately for him this massive eating regime began while he was serving in the Marine Corps, so most of the food was **free**.

Later on during an 8 month time frame (when he was back into the civilian sector) he trained and dieted down to 187 pounds and won a Mr. Universe title. It would have been interesting to make a comparison of his computed grocery bill while in the military and that of when he was a civilian and dieting down in bodyweight. With the exception of Bruce Randall's case, an increase in your grocery bill, while unavoidable is not a long term issue.

A **second** disadvantage with an accelerated muscular bulk routine is that of stretch marks and Richard found about this problem the hard way during his gain of **25 Pounds in 21 Days**.

Because he bulked up so quickly the skin around his anterior deltoids, upper pectorals, inner thighs and even gluteus maximus, were stretched beyond the limits of its normal elasticity.

As a result he developed silvery scars called stretch marks. Though he used a seemingly flawless "technique-emphasis" of a full stretch and contraction on each and every rep of a set for a particular exercise, he said that if he had it to do over again he would have avoided going to a full extension ([as mentioned previously the Lat pull-downs was one exercise he didn't do to full extension](#)) on any joint in any exercise. He felt hypothetically that this caution and common sense approach might have helped him to avoid the stretch marks.

Summed up the advantages of an accelerated muscular bulk routine seemed to outweigh the disadvantages, at least that's the way Richard perceived it.

Skepticism

Reflecting back to 1966, I was only 20 years old and very impressionable and a bit naive so I have to look deep within and ask myself if I really believed that Richard Simons actually gained **25 Pounds in 21 Day** and with only "9" muscle-pumping workouts. Personally, I believe he did and I'll tell you why shortly.

I realize that some of you reading this report may be somewhat skeptical and take issue with regard to the **3 x 3 x 3 Exercise System** of bodybuilding he used and **The Transformation!**, or physical metamorphosis resulting from it. I would be amiss if I didn't briefly comment on each of these two issues.

Evolutionary High-Volume Training Was in Vogue

I realize that many **HIT** (high intensity training) and **HEAVY DUTY** (www.mikementzer.com) advocates (who believe that one of the keys to any weight training is intensity within a set rather than the quantity of sets performed) will literally freak when looking at the training approach he took on for it appears that in addition to the adrenaline fueled intensity he put into each exercise he

also placed a lot of emphasis on the quantity (volume) of sets (up to 18 per exercise) he used to achieve his goals.

It should be noted that Evolutionary high-volume training programs were in vogue back in the 1960's, as evidenced by the **Japanese Counter-Split Body Blast System** outlined at the beginning of this e-report and of course there was the **PHA** (Peripheral Heart Action) system that the **1966 AAU Mr. America, Robert Steven Gajda** and others such as **Frank Zane** and **Sergio Oliva** and others were following at the time.



It wasn't uncommon to see **Bob Gajda**, for example, **performing two hundred plus sets and beyond in just one workout**. By comparison the total number of sets **Richard** on the other hand was **averaging only 56 sets per workout** which would seem to be a modified high-volume training style when compared to the PHA system. The bottom line was, high-volume training, however you define it, seemed to be productive for the contest entering and winning bodybuilders of that era.

There were many reasons why Richard succeeded with the high-volume training approach. There are **7** that immediately come to mind:

1 – He was an ultimate **Iron Lord** in his early 20's who had an **over abundance of natural growth hormone** pouring over the pours of his awakened and alert muscle fibers.

2 – He had the **Mind Power Doctrine of an Iron Warrior** (**read Bonus No. 1 at the conclusion of this e-report**), which was an ABSOLUTE BELIEF IN THE EFFECTIVENESS AND THE END RESULT OF THE PROCESS HE WAS USING. Richard said that it is was his mind that provided the impetus to succeed with the challenging **3 x 3 x 3 Exercise System** with the end result being a mega-gain of **25 Pounds in 21 Days**.

3 – Richard said that from his previous training experiences he knew what the greatest number of sets per exercise he could do and still recover from overnight.

I couldn't help but notice that there were also far fewer movements per body part in Richard's workouts than in most training programs. I discovered that Richard did this intentionally because from his experience and insights in the iron game, he realized that in almost every instance, bodybuilders even those in advanced stages, tend to perform too many movements per body part and thus actually over train causing a slowdown in muscle gains.

So the logic to his high-volume training approach was to overload specific muscle groups on particular days (**Monday-Wednesday-Friday**) and have adequate intervals of rest provided for on the remaining four days of the week.

He felt that if he trained anymore often than 3 days a week he would become **over-trained** (as he did when using the **Japanese Counter-Split Body Blast System**) He felt that this strategic training approach (**please remember the training concepts espoused within this e-report was what was generally accepted in the 1960's**) allowed for the twofold recovery of the muscles and central nervous system.

4 – Rest & Relaxation were of vital importance. He would get at least **eight to nine hours of sleep** a night and **three hours of total relaxation** throughout each day, which he felt was the equivalent to a night's sleep.

5 – Adequate nutritional support (i.e. Mega-Calorie or Ultra Mass Diet).

6 - During the 21 days he avoided working at a normal job.

7- He abstained from alcohol and cigarettes because he felt that they rob the body of valuable energy and deplete important nutrients. They also suppress the appetite and disrupt the metabolic rate.

Defending The Transformation!

The skeptic might say that a gain of **25 Pounds in 21 Days** is a case of "Sounds Too Good to Be True."

However I might point out that as far back as the 1930s, there were bodybuilders making mega-gains of 25-30 pounds in a month or less, the two most famous names being **Joseph Curtis Hise** and **Buck Reed**.

Enter into the 1950s and one had to marvel at ability of the late "Monarch of Musceldom" **John C. Grimek**, at a height of 5' 8", could vary his weight 30 pounds or so in a couple of weeks, either up or down and at one time went up to 240 pounds.



John C. Grimek
www.johngrimek.com

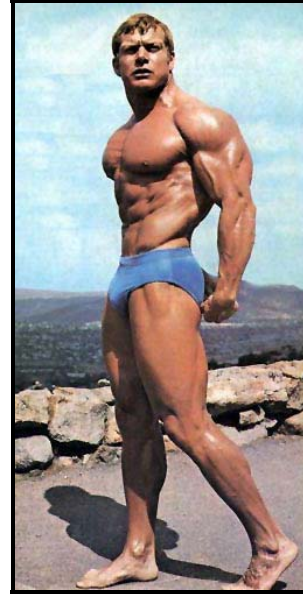

Ralph Kroger

Richard Simons was not the sole boss of **mega-gain theory** in the 1960s. Other bodybuilders such as AAU Mr. America competitor **Ralph Kroger** stated on numerous occasions that he could make gains of 30-40 pounds in a month if need be. Another person that comes to mind during this era was a bodybuilder named **Vern Bickel**, who gained 15 pounds in 17 days.

Fast forward to the 1970's there are a couple of references pertaining to the **mega-gain theory** that I want to make mention of.

Probable the most famous and well documented (actual research papers) mega-gain physique transformation (off all time) was...

The Colorado Experiment in 1972-73 showcasing the 1971 AAU Mr. America, **Casey Viator** (www.caseyviator.com). Casey gained more than **60 Pounds** (of muscular mass) **in 28 Days** and with only "**12**" (high-intensity) workouts, each of which were less than 30 minutes. Check out the rather dramatic before and after photo's of Casey on the following page.



Casey Viator (before)



Casey Viator (28 Days After)

Then In 1974, **Ernest F. Cottrell**, a feature writer and ex-Editor of Joe Weider's Muscle Builder/ Power magazine, gained 38 pounds in less than two weeks, while performing only 4 total body workouts using a special exercise apparatus (he invented in 1953) called a "**Maxi-Sizer**".

Ernest F. Cottrell never went public with his "**Maxi-Sizer**" concept but he did the next best thing for his bodybuilding mail-order students. He designed a 3-month exercise course that consisted of a slightly unusual weight-training routine that changed every month, plus a refreshing 1-Week Preparatory Work-out that is used just before, and in-between the regular course. He said that many bodybuilders will make 2 to 3 times the progress they previously realized...!

He called this program the **SPECIAL 118-DAY SCIENTIFIC BODY BUILDING EXPERIMENT**. I've included this program as **Bonus No. 3** at the end of this e-report.

Here's a look at the before and after photo's, statistics, and a blueprint of "Maxi-Sizer" he used during his physique transformation.

Ernest F. Cottrell's Physique Transformation

Before



After



193-lbs. on Aug. 18th '74

Chest (Nor.) -----47"
Upper Arms-----16-1/4"
Forearms----- 14"
Waist-----43"
Thighs----- 24-1/4"
Calves-----16-1/2"

231-lbs. on Sept. 1st '74

Chest (Nor.)-----51"
Upper Arms-----18-1/2"
Forearms-----15"
Waist----- 37"
Thighs----- 28-1/2"
Calves----- 17-1/2"

Height---5'-11"

Age-----41

**Gains: Chest 4"; Upper Arms 2-1/4"; Forearms 1";
 Thighs 4-1/4"; Calves 1"; and Bodyweight 38 lbs.**

As you can see Ernest gained 38-lbs. He was bulking up...but just look at the almost complete loss of that large roll of fat (6 full inches) off his waist, too! Notice also in the "after" photo, Ernie was not pumped up and posing. When good solid muscle size and tone are present, the lats won't let the arms hang down to the sides, etc.

"Maxi-Sizer"

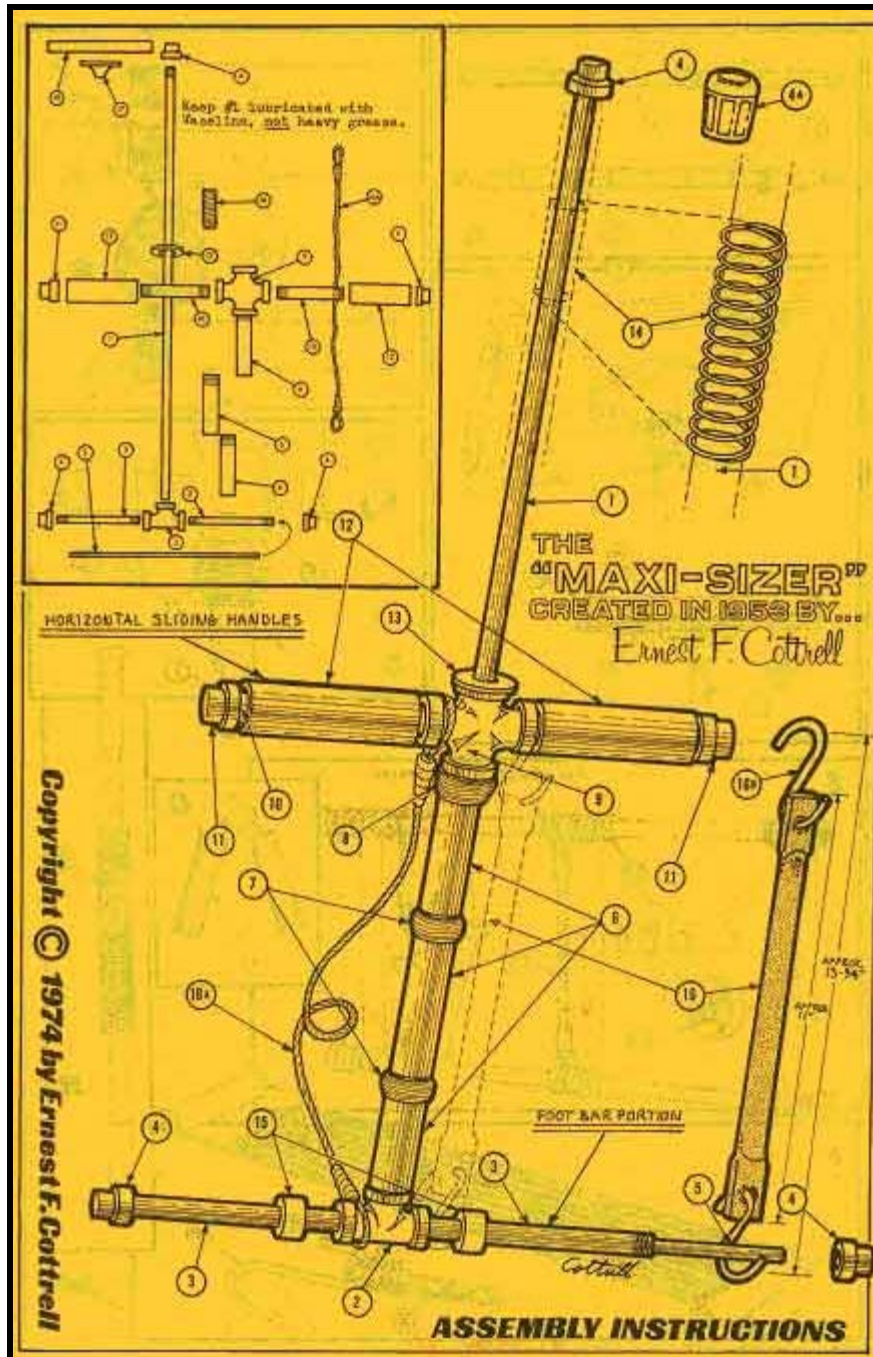

Blue print page No. 1 (shown) of 4 (not shown)

One of the more recent physique transformations that I am aware of occurred in 1995 when **David Hudlow** gained 18.5 pounds of muscle in 11 days using a system called **Upside-Down Bodybuilding**, while under the supervision of Dr. Ellington Darden.

It is not my intent to discuss whether or not the gains mentioned in each of the cases cited were over-hyped, and/or what the ratios of muscle to fat gain (although in the **Colorado Experiment**, Casey Viator gained more than 45 pounds of bodyweight while losing about 19 pounds of fat) were.

And of course there is always the controversial and mysterious concept of **Muscle Memory Recall** that enters into the gain theory as well. Here is a good example of what I am talking about.

When Arnold Schwarzenegger finished the movie “Pumping Iron” in 1975, he weighed 210 pounds. But yet he quickly gained 25 pounds and won the IFBB Mr. Olympia that same year. Arnold didn’t have a problem to gain 25 pounds. He only had the problem of regaining it. He had these 25 pounds once already so it was just a matter of his muscles remembering this.

Perhaps Richard Simons experienced the rapid regain of 25 pounds (through Muscle Memory Recall) that he had once already. I didn’t even think to ask him about it and of course I wouldn’t have used the term “Muscle Memory Recall” since it was not a buzz word term in the 1960’s.

It’s pretty much a given that the “Muscle Memory Recall” concept entered into the **Colorado Experiment** with Casey Viator to some degree and very well could have with the **Ernest F. Cottrell’s physique transformation** as well.

Having said all of that I hope that the 7 examples that I have just mentioned lends some credibility to the fact that Richard Simons did in fact gain **25 Pounds in (A) 21 Day (Mass Up Cycle)** and with only **“9” Muscle Pumping Workouts!** As dramatic as Richards’s transformation and the others may seem they did not come from difficult, desperate or even helpless body conditions.

Hindsight is always 20/20 but I wish I had obtained some documented photo support of his transformation but unfortunately I didn’t. There is one other factor in Richards amazing transformation that needs to be mentioned and it is.....

The Anabolic Pharmacology Factor

To accelerate strength gains and a mild muscle hardness Richard was very candid and stated that he took 25 milligrams per day of the oral anabolic steroid **Anavar** (Oxandrolone) for 21 days only.

I have no idea how much effect the very minimal daily dosages (Ten 2.5 milligram tablets) of **Anavar** had on the overall gain factor of **25 Pounds in 21**

Days as opposed to non-anabolic steroid use and I doubt Richard did either. Richard provided the information on his use of **Anavar** as a point of view and **NOT** as a recommendation for others to follow.

Ironically during the short time that Richard was training at the “**Fitness and Figure Gym**” in Hialeah, Florida in 1966, the owner Donne Hale (my bodybuilding mentor) had just published the first ever ground breaking article on anabolic drugs in his magazine, **The Florida WEIGHT-MAN** (Vol. II, No. I).

What was so cutting edge about the article is that it was the first ever publicized discussion to appear in a bodybuilding magazine between two individuals, Donne Hale and Dr. Bill Barad, about the previously “behind-closed-doors” guarded talk about subject of anabolic steroids. Here then is that brutally frank and revealing article.

The Florida WEIGHT-MAN, Vol. II, No. I
TISSUE DRUGS! BLESSING OR CURSE?
by Donne Hale



On the next page begins a defense of the tissue drugs, written to me by BILL BARAD, for publication in the Florida Weight Man magazine. A physique star and a pharmacist, he has used the hormones for years. Though I definitely do not share Bill’s views, I feel my readers deserve the opportunity to see both sides.

Bill Barad Speaks...



In answer to your recent letter, I'm not at all adverse to being quoted, so long as I'm not quoted out of context. However, I would much prefer that this letter not be cut or condensed in any way, reprinted in its entirety.

First, I'd like to make my position clear, concerning the anabolic hormones or 'tissue drugs', as you call them. I'm neither-for-or against their use, as far as the general public is concerned. Each individual is a complex combination of innumerable factors, both physical and psychological, and certainly no one can say truthfully that anything is good for EVERYONE. These hormones are contraindicated in certain diseased conditions of the prostate and liver. However, under normal condition, I feel that they are very useful and beneficial for the average bodybuilder when used with discretion.

Most of the arguments I've heard against the use of these substances have revolved about the theme that it isn't natural to take hormones or drugs. I would answer by simply stating that neither is it natural to drink milk, eat bread or cooked food of any kind, use salt, imbibe wheat germ oil, take vitamin, mineral or concentrated protein supplements in any form. It's even unnatural to bathe daily as we do, and exercising with weights on a regular or a strenuous basis is not natural. Yet, who condemns these practices because they are unnatural? I'd hate to be forced to live in a strictly natural manner. I would then necessarily be uncivilized and, I am convinced, quite unhealthy.

Another argument is that great 'authorities' Hoffman and Weider are against using them. This I can answer simply by pointing out that hormones cannot be sold legally by these self-styled authorities. Since no profit is in it for them, as there is in the products they peddle, it isn't difficult to see why they're against

them. After all, if bodybuilders turned to effective hormones, how would the health food boys stay in business?

There have been some adverse reactions due to misuse of these substances, to be sure. However, these reactions have been extremely rare and almost always associated with over dosage in individuals who were being treated medically for various conditions of poor health affecting the metabolism of these hormones. Besides, all known side effects of these substances are completely reversible upon reduction or withdrawal of dosage. There are far more people whose health was damaged by milk, eggs, wheat, vitamin supplements, etc. In fact, there is hardly a food or drink which hasn't been harmful to someone.

Would anyone condemn the use of insulin, because it's unnatural? Or thyroid extract or cortisone and its derivatives? If individuals must use these substances, nothing can convince them not to take their daily dose, because it's unnatural or because a few persons may have had an adverse reaction from taking too much. They know that their daily doses are all that stand between themselves and death.

My experience with anabolic hormones has been very fruitful. I've been using them for almost ten years now and I can honestly say they have benefited me greatly. I will soon be 46 (1966) and I find my physical development and total vitality to be on a higher plane with much less effort than it was, ten years ago. I firmly believe that aging is chemical and that some day, via hormone therapy, we'll be able to extend the prime of life far beyond what it is today. Meanwhile, I'll not be twiddling my thumbs waiting...I'll take advantage of every trick at my disposal, natural or unnatural, to extend my prime as long as I can; for I've found the anabolic hormones do much more than merely enhance muscular size – they have a toning effect on practically all my bodily functions.

To explain how these hormones accomplished their actions, would take volumes to delve into the many faceted and intricate workings involved and then it would only be theory. The only thing you can say as certain is that they work and, in some cases, are life saving.

I could tell you more about the history of anabolic hormones – how they are derived, etc. – but it would make too long a letter. I would, however, like to bring one more item to your attention. I know of three Mr. Americas and at least one Mr. Florida, also several movie stars who rose to glory when taking these hormones. In fact, one of the greatest and best known of all bodybuilders became Mr. America in the 1940's, after taking testosterone – the parent hormone from which the more recent anabolic hormones have been derived. He later became Mr. Universe and even today, twenty years later, he is still considered by many, to be the greatest of them all. In closing, I look forward to seeing this letter presented to your readers. – **Bill Barad**

Donne Hales Responds



Donne at his store, Hales Health Foods, in Miami, Florida in 1966

Bill Barad is the only man I know who used tissue drugs successfully, for so long. His case is encouraging but certainly not conclusive evidence. Favorable results such as weight gain, size, more energy, power, increase of hardness in muscles have been reported. Others have had reactions such as a bleeding from nose and rectum, chest pains, loss of sexual drive, nausea, upset liver, appearance of puffiness. It is obvious that much is to be learned and results vary due to body chemistry or other factors.

The building up phase of metabolism is anabolism, thus giving its name to this type of drug. A hormone, of course, is an “exciter” in the system; it takes only an infinitesimal bit to vastly effect body chemistry, as they are so powerful. Here is one theory of how the anabolic hormones work – the cell’s membrane acts like a sieve, permitting some elements to enter the cell, rapidly, others slowly and some, not at all. A molecule of growth hormone may drape itself over the membrane, thus changing the nature of the “sieve”. Maybe it lets more amino’s enter, giving the enzymes more to work with and forming more protein, which accelerates the cell growth and multiplication. If this action takes place in the body’s billions of cells, rapid growth will result. Common sense should indicate that changing normal metabolism as they do, tissue drugs **MUST** be considered dangerous. Read this, from *THE BODY*, by Nourse, “...hormonal activity must remain in delicate balance – like salt in a stew – or the entire body will be thrown out of kilter.” Does this make you think?

Anabolic hormones are used following surgery or a long illness, with people who do not metabolize properly; they were intended for therapeutic use and nothing else! Their labels specifically warn that lengthy use is not recommended and advise supervision by a doctor while taking them. Does that sound as if they are **NOT** dangerous? Don’t kid yourself that they are like penicillin, insulin or other drugs that have known side effects. Those medicines are used in cases of desperation, with the patient willing to risk the bad effects. This is not so with a

tissue drug – if you're using one, it's due to vanity. If you ask me, that's a foolish reason for taking serious risks!

It is unfortunate that there isn't yet definite evidence of serious harm from these hormone drugs. Side effects from chemicals don't usually show up until years later and if the product isn't widely used, reports are slower. Sulfonamides were lauded as a safe, wonder drug in 1957; in 1964, it was proven they caused severe blood disease or ulcerations. A flu vaccine popular for ten years was pinned down in 1965 as causing tumors. Because you don't drop dead when it is taken, doesn't mean a chemical is safe!

Another mistake is to assume that these anabolic hormones must be safe, or they could not be sold. The Food & Drug Administration is notoriously lax in protecting the public from the powerful drug monopolies. That office has continually passed drugs as safe that were later proved dangerous; just as often, they have failed to act against products known to be harmful, allowing them to remain on drug shelves, with a change in the label. In recent years, they have passed chloromycetin, orabilex, parnate, enovid and others; all have caused drastic results – even death, in some cases. Physicians can not be relied upon for protection, even if sincere. The AMA says that 90% of the drugs known to a doctor when he begins practice, will have replaced during his career. They also add that less than 20% of the new ones will have received adequate testing! Drug companies are tremendous businesses; I do not find it strange to think they might place profits ahead of public welfare! No, the best protection is still common sense.

Modern society is ruled by a slap-happy way of thinking – it blissfully accepts poison sprays, chemicals in food and yes, hormone drugs, without question. They smugly quote “After all, we're healthier than ever”. And I say, the Hell we are! Juggling statistics makes it appear we live longer, but we can not ignore the alarming increase in all degenerative diseases, like cancer. In my mind, this brings us back to tissue drugs. In A MATTER OF LIFE & DEATH by Bailey, this appears, “...all cancers share a basic similarity: uncontrolled, spreading growth”. If you recall the way in which the anabolic hormones probably react on metabolism, does that sound comforting? And then this, “the law says that cells should grow, but only enough to benefit the whole organisms”. Some will accuse me of using “scare tactics”. I am, and with good reason – if you're toying with the tissue drugs, you SHOULD be scared!

Most men who use anabolic hormones do so in ignorance; they believe they must use them to get a top physique and they do not have any idea of their evil potential. Some of the greatest physiques in history were developed BEFORE the hormone crazy, including the immortal John C. Grimek. Today, we still have stars who have never touched them.

Although tissue drugs do seem to stimulate growth, they do not always produce desired results. Immediate ill effects often appear and, in the light of scanty knowledge about hormonal effect on bodily processes, there is a definite

risk of possible later side effects. In the face of all this, if being big is your only objective in life, if it is more important to you than possible danger to your health, I have no further arguments to offer. After all, it IS your life. – **Donne Hale**

A Dennis B. Weis Capsule Comment

I was in 100% agreement with Donne's response to Bill Barad and on a personal note I would say that, unless you are a pituitary dwarf or 99 years old and weight 60 pounds, you **shouldn't ever risk the use of anabolic steroids (or thyroid drugs for that matter)**.

Closing Comments

This program-neither the diet nor the workouts are **NOT** recommended for beginners or for bodybuilders age 40 and beyond as it might cause side effects (and blowback) of Central nervous system shock, Adrenalin gland exhaustion, Rapid testosterone and growth hormone depletion or high levels of the catabolic hormone "Cortisol". Remember that **recovery must always precede muscle growth!**

There is no easy way, no shortcuts in bodybuilding. Learn to workout hard, eat well, get enough sleep, don't consume alcoholic beverages or smoke. Pay your dues.

I hope you have enjoyed reading about the physical force protocols and nutrition that one man (Richard Simons) used to **MAKE A REMARKABLE METAMORPHESIS 25 POUND WEIGHT GAIN IN ONLY 21 DAYS!**

Bonus Report No. 1

Mind Power Doctrine

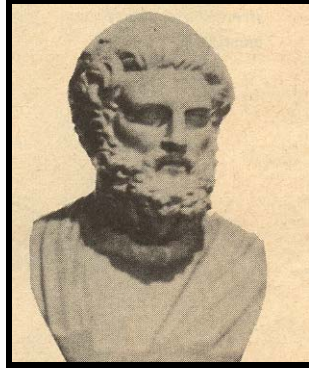

of an

Iron Warrior

By Dennis B. Weis "The Yukon Hercules"

There is an old adage that says, "Think big, act big, to get big." It is therefore very important to learn about mind doctrine management if you want to become bigger and stronger.

The mind power doctrine of an iron warrior can be broken down into three simple but inseparable factors: *Belief*, *Vision*, and *Method*.

Belief is the degree of self-confidence (trust) a person has in himself or herself. The difference between an iron warrior bodybuilding champion and others is the size of his or her belief.

A mediocre bodybuilder might express his belief like this: "I'd like to be an iron warrior bodybuilding champion some time, maybe, if it's not too hard." Lee Haney, eight-time Mr. Olympia, puts it this way: "I want to be a champion. That's what I see Lee Haney as, a Champion. There's nothing wrong with having a healthy ego. That's why there are sheep and there are shepherds." Notice the difference between the two beliefs?

Vision is the appropriate and attainable short- and long-term goals. Adding 1/2 inch to the arms in one day is a short-term goal.

Method is the process used to fulfill the vision. For example, the process for fulfilling the vision of adding 1/2 inch to the arms in one day can be achieved by following the advice in my **SPECIAL BIG ARMS REPORT** (available at: www.dennisbweis.com).

It is important that you begin thinking like an iron warrior bodybuilding champion by adopting the mind power doctrine of **Belief, Vision, and Method**. Doing this will help you access the reservoir of untapped strength within your body. This is vital, especially if you are into the advanced stages of, say, German Volume Training (read about this unique training protocol in issue #118 at www.t-mag.com), where the program becomes such a bully that you may begin to experience self-imposed limitations of frustration, doubt, and indecision. You may even begin to question your energy, endurance, sanity, and willingness to carry a program such as German Volume Training to its completion.

Such self-imposed limitations are indeed major barriers of the subconscious mind and, as a result, can cause temporary lapses of mental concentration. It is absolutely paramount that you let go of disruptive influences such as frustration, doubt, and indecision and focus on the light of total awareness or *laser concentration* (metaphysical) needed to complete a program such as German Volume Training or others.

Bill Pearl, a multi-Mr. Universe, has stated at a number of his super-seminars that "you can't take anything negative you are doing in the sport of bodybuilding and turn it into positive results. It won't work." He goes on to say that "You must condition your subconscious mind to think that you are getting bigger and training with more intensity and your body will respond accordingly."

To condition the subconscious mind in the manner that Bill Pearl described requires the implementation of a couple of self-actualization resources.

First, begin reprogramming your subconscious mind with some very precise, measurable, and powerful motivational affirmations. Here are some examples: Mentally or audibly with full force and conviction, say (to yourself):

"I will train each occurring set of the exercise at hand (of say the Standing Two-Hands Barbell Curl or the Standing Barbell Press Overhead etc.) with ***focused intensity***."

"I will ***conquer and dominate*** each set with an unchained will to ***triumph and succeed***."

"I will ***prevail*** in the moment and take myself to absolute physical levels that ***surpass*** and rival previous ones."

I will ***conquer and dominate*** every single rep of the upcoming set and get progressively ***stronger*** while doing so."

"I will masterfully ***succeed*** in the gym."

"My upper arms will ***grow bigger*** by ½ inch."

"Today I will perform the most intelligent, rigorous, and ***locked-in*** priority workout of my life."

Notice the emphasized words in each of the motivational affirmations. They are called "trigger words" and serve as a mental stimulus to unite the muscle fibers in your being to respond to their fullest potential. You can choose other trigger words and specific and concise positive reinforcement phrases if you wish.

Specific and concise positive reinforcement phrases (motivational affirmations) should personally reflect an unchained power and commanding dominance to master the direction of your thoughts. Here are some examples:

- ***Weak reinforcement*** - Make my legs stronger.
- ***Specific/concise reinforcement*** - to squat 400 pounds slightly below parallel with perfect form for a big triple.
- ***Weak reinforcement*** - to eat better or really zone in on my diet starting next week.
- ***Specific/concise reinforcement*** - to consume no more than 3,000 calories a day with a ratio of calorie intake to be 40% complete protein, 50% complex carbohydrates, and 10% unsaturated fats, beginning next Monday morning.

- *Weak reinforcement* - to lose weight.
- *Specific/concise reinforcement* - to weigh 210 pounds and have 10% bodyfat or lower.
- *Weak reinforcement* - to get my bench press up.
- *Specific/concise reinforcement* - to increase my maximum single effort in the flat bench press from 300 to 300 pounds in the next 10 to 12 weeks.

Specific/concise reinforcements are measurable, meaning that two independent people should be able to agree within acceptable limits that the reinforcements occurred or did not occur. Weak reinforcements are less defined and much more difficult to measure in terms of results.

The motivational affirmations or reinforcements that I have been discussing are an important power of the mind power doctrine. The subconscious mind cannot distinguish between what is real and what is not. You must therefore, with a commanding dominance, deeply, fully, thoroughly, and completely convince your subconscious mind of your belief in the motivational affirmations. Only then can you create your own realities.

So, with a burning inner conviction, *emotionally*, with all of the force, all of the drive, and all of the desire (desire is the font of will power) that you are capable of feeling, mentally or verbally repeat 10-15 times your favorite precise, measurable, and powerful motivational affirmations. As you continue to repeat these phrases, you will begin to feel absolute sensations of unchained power flowing, pulsing, and surging through you both mentally and physically.

The *second* Self-Actualization Resource is mental imagery-rehearsal of any training protocol you are currently following (e.g., German Volume, Titan Training System, etc.). It is said that *what the mind can conceive and believe, the body can achieve*. And so it is with this thought that I'll begin with an explanation of mental imagery-rehearsal by borrowing some of the commanding and dominant insights and expressions of mind doctrine techniques that many world champion bodybuilders use to access peak performance in the gym.

Mental imagery-rehearsal and its application to the iron athlete is a thoughtful and intelligent two-stage event consisting of pre-workout and one-set interval preparation. Here's a brief look at each.

Stage I: Pre-Workout Imagery Rehearsal

Simply stated, you will mentally visualize (like seeing a series of pictures on a movie screen), by bringing images into the mind, all the simple and complex elements associated with the forthcoming workout.

About 15 to 30 minutes prior to your workout, go to a place of solitude (void of ringing telephones, ticking clocks, people talking, and bright lights). Sit in a comfortable chair. Close your eyes and begin slowly and deeply to breathe in and out through your nose and begin to relax (called relaxed breathing).

Now, begin mentally to empty your mind of all thoughts that do not pertain to the workout. Don't let intruding thoughts attract your attention. This could be any thought such as what you did yesterday, what you are going to be doing after the workout. Sometimes a remark that someone made that you didn't particularly like will pop back into your head, but don't let it.

Drive away the nagging negative voice from the dungeon of your subconscious mind that might be telling you to skip your workout for one reason or another. Mentally see yourself well rested, recovered, and stronger from your last workout a couple of days ago.

As you continue to progress into a relaxed state, visualize the collective atmosphere of the training energy in the gym that is being generated by the other iron warriors. Feel this sensation and how it gives you a special power to dominate the heavy iron.

Become a master of training by mentally reproducing the tracking patterns of the exercises rep for rep, set for set. Repeat this process several times in your mind.

Finally, see yourself at the conclusion of the workout with a bone-deep, growth-producing, vein-choked pump in the muscles of the upper arms.

When the mental pictures and related sensations that you expect to see are clear and vivid in the mirror of your mind, open your eyes. You should now have an unyielding commitment, intense desire, determined persistence, and powerful will to succeed moving, flowing, pulsing, and surging through your entire being.

It's time then to get up out of the chair and step into the hardcore trenches of the gym.

Stage II: One-Set Mental Imagery Rehearsal

This stage of mental imagery-rehearsal is conducted approximately 10-15 seconds prior to each set of a prescribed exercise methodic. While standing or sitting, however you feel most comfortable, close your eyes and take in and exhale short breaths of air as you mentally prepare (with **selective focus**) for the moment at hand.

You must go to that place in your consciousness where there is *no pain, no negative influences, no fear*, a state of mind where only *positive forces* dwell.

Your mind must be **time-locked** (cohesive) with the muscles in order to do battle with the heavy iron. Begin by picturing in your mind's eye the bench, the bar, the plates. Imagine this so intensely that you can smell the sweat, feel the knurling on the bar, hear the plates rattle, and so forth.

If you are going to be performing the classic standing two-hands barbell curl, for example, recreate all of the exercise mastery techniques that are necessary for the successful completion of each gut-wrenching rep of the set.

The more organized and detailed you can make this ritual of mentally focusing in one-set intervals, the better chance you will have for training to the outer limits of muscular size and strength. Here's another way to explain it. Think of how organized and detailed the ritual of mental imagery-rehearsal would be if it related to making love to a beautiful woman. The details are never slippery or vague. They're always clear and vivid.

As the magnitude of mental imagery-rehearsal for the upcoming set becomes more and more vivid, you will begin to feel torrents of unleashed fury and your heart will beat in a manner that reflects your ability to dominate and prevail in the moment. Open your eyes. You are now 100%

mentally focused and psyched. Go for it! **It's time to lift the HEAVY IRON!**

Tip: During your workout, play your own favorite high-energy music to trigger strong energy responses.

Closing Thoughts

I have explained the mind power doctrine of an iron warrior in very general and broad terms. This is thoughtfully done, because accessing peak performance is highly individual. To awaken the sleeping giant within, I suggest you visit the following websites for more information on mental training:

- www.skiplacour.com
- www.ironmind.com
- www.naturalstrength.com
- www.leelabrada.com
- www.frankzane.com

Develop the positive mental attitude of a champion Iron Warrior by thinking **BIG** and thinking **SUCCESS**. Never give in. Always remember; Lifting The Heavy Iron Is **A CHALLENGE**, Every Set Is **A WAR** and Every Rep Is **A Victory**. **Conceive, Believe, Achieve** your goals and dreams. Commence positive action. Do this and your muscle size and strength can't help but **grow, Grow, Grow!!!**

BONUS REPORT No. 2

TEN HOT TIPS! & OTHER NUTRITIONAL STRATEGIES “FOR GAINING MUSCULAR BODY WEIGHT”

By: Dennis B. Weis “The Yukon Hercules”

Ten Hot Tips!

1. To gain a pound of muscle per week, you need to do several high intensity workouts *and* increase your daily food consumption by 100-200 calories per day. This is what you want to do is gain weight in the form of *muscle*, not fat, and muscle and fat differ in water, protein, and fat content.

This chemical breakdown shows that our skeletal muscle weight is made up of almost three-quarters water. We now know that muscle and fat are two diverse substances that differ considerably in composition. This leads us to the subject of muscles turning to fat, a common myth.

It simply isn't true that muscles can turn into fat, but it's not hard to understand how this misconception arises.

A football player at the peak of his career, for example, is playing the game with great intensity and regularity each week. He is also consuming a tremendous number of calories each day to sustain this energy output.

Now, look what happens when he retires. He is no longer playing football, so his energy requirements are noticeably lower. While he may continue to work out with weights, over a period of months, this activity usually ceases completely, and as a result, his energy requirements are dramatically reduced. But, at the same time, the football player is consuming the same number of calories per day as when he was playing football and working out with weights.

Basically, this is what happens: lack of physical activity such as playing football and pumping iron has caused the muscles to atrophy or diminish in cell size.

Consuming more calories than he needs contributes to some rather large gains in body fat. Some of this body fat forms a layer between the skin and the muscle cell (which has diminished in size from lack of exercise stimuli), and this gives the illusion of muscle turning to fat. If this person had a proper knowledge of nutrition and exercise, he would have decreased his caloric intake in accordance with his marked decrease in physical activity.

Had he also continued with some type of workouts, whether aerobics or circuit weight training, he would have been able to maintain stimulus to his muscles while preventing fat gain by reducing his caloric intake. This example disproves the myth that muscle turns to fat, but it also shows what can happen to an athlete in any sport who does not eat or train smart.

Eating to gain requires that you figure out your daily menu for each day of the week. Eat basically the same foods from each of the food groups as you normally would. If you do make a substitute (for sanity's sake) be sure the replacement is of the same caloric value. In this way you won't constantly have to refer to a calorie book.

2. Slow down your basal metabolic rate by doing absolutely nothing beyond your daily obligations such as family, job, and workouts. Don't participate in any extra sports activities whether bowling, hockey, golf, marathon running, racquet sports, soccer, softball, tennis, volleyball, or wrestling.

3. Try to get eight to nine hours of sleep each night. We are speaking of quality sleep, where you retire an hour or so before midnight and sleep through until 7:00 A.M. or so. If at all possible, try to take a short one-hour nap during the afternoon. Those of you who are working at a job requiring a swing or graveyard shift will have to adjust your sleeping hours accordingly.

4. Don't stand when you can sit, walk when you can ride, etc.

5. Don't smoke, because this constricts the blood capillary beds in the body, which in turn has a debilitating effect on oxygen-carrying enzymes in the body. Smoking also triggers a risk in blood sugar levels, which depresses your appetite.

Now you can begin to understand why smokers who quit gain weight rapidly (which is not to say that those who are overweight should start smoking as a means of depressing the appetite to lose weight). Smoking also destroys vitamin C at the rate of 35 milligrams (the amount found in one orange) per cigarette.

6. Do *not* exercise directly before a meal since that may depress your appetite. **To stimulate your appetite:** Mix one egg yolk with 2 ounces of red wine and drink this concoction ½ hour before a scheduled meal.
7. Avoid those uptight situations that upset the nervous system and burn up valuable calories. To do so you must know yourself and how to react to people. Eliminate anger, anxiety, fear, frustration, and the like whenever possible. Work at developing a physical ease and a positive energy source.
8. Never allow yourself to get hungry. To prevent hunger, try eating four or five times per day, perhaps three substantial main meals with three smaller feedings or snacks in between. This meal schedule will allow you the best utilization and assimilation of your foods.
9. Be sure to include digestive enzyme tablets (pineapple enzymes) at each meal or snack to improve digestion and absorption.
10. After very diligently following the advice given in secrets 1 – 9, some of you may find that gains in muscular body weight are still not apparent. If you suspect that the problem may be due to your daily caloric consumption, try the unique calorie *blitz method* described below for gaining that extra muscular body weight you desire.

THE UNIQUE CALORIE BLITZ METHOD

To explain this procedure, here is a hypothetical example: you are a 180-pound male bodybuilder who is moderately active, and your daily estimated energy expenditure is 3,400 calories. In order to gain additional muscular body weight, include *two extra* calories per pound of your existing body weight per day. If you are still not making any progress then each week for the next six weeks you should add *one extra* calorie per pound of body weight, up to a maximum (for both men and women) of eight calories.

SEVEN-WEEK CALORIE BLITZ CYCLE

Current Body Weight: 180 Pounds Daily Calories Consumed:
3,440

WEEK NO	EXTRA CALORIES PER DAY	DAILY CALORIES CONSUMED
1	2 x body weight = 360	3,800
2	3 x body weight = 540	3,980
3	4 x body weight = 720	4,160
4	5 x body weight = 900	4,340
5	6 x body weight=1,080	4,520
6	7 x body weight=1,260	4,700
7	8 x body weight=1,440	4,880

The 7-week blitz gaining cycles can be expanded to a 14-week cycle in which you add one calorie every two weeks as opposed to every week.

Also, you may begin to notice weight gains before the 7 or 14 weeks are up. If this is the case, after you have reached your desired additional body weight using this system, gradually drop back off this blitz calorie intake to a maintenance calorie intake to a maintenance calorie level that will maintain your new body weight.

Both men and women can use this blitz method of gaining weight though I feel that these extremities are not necessary for 99 percent of women. Secret No. 1 will prove adequate for most women athletes.

Also, you may begin to notice weight gains before the 7 or 14 weeks are up. If this is the case, after you have reached your desired additional body weight using this system, gradually drop back off this blitz calorie intake to a maintenance calorie level that will maintain your new body weight.

Gaining additional body weight in the manner described requires that you eat a lot of food. Those of you who simply can't get along with this requirement might try mixing up one of the blender drinks listed at the end of this bonus report and consider this part of your daily calorie consumption. You can even carry this one step further by setting your alarm clock for an early morning rising, say around 2:00 A.M. or so, have a protein drink at this time, and then get back to sleep as quickly as possible.

Free form **amino acid tablets** and **defatted desiccated liver tablets** (personally I use and recommend the Beverly International brand at www.bodybuildingworld.com) are very good supplements to carry with you on the job or at school.

OTHER NUTRITIONAL STRATEGIES “FOR GAINING MUSCULAR BODY WEIGHT”

Vince Gironda's "3" Natural Anabolic Secrets

The late, Vince Gironda always seemed to have some natural anabolic secrets in his bag of goodies. Here are "3" of his secrets.

Secret #1

Vince used to suggest taking three to four **amino acid tablets** and 3 to 10 **liver tablets** every three hours to help keep the body in a positive nitrogen state between meals and during those times when a person can't eat a normal meal or snack.

(Liver contains a red protein pigment called Cytochrome P-450 which accounts for the endurance factors that many hard training bodybuilders receive from taking it. Back in the 60's, 70's and 80's it was common to see many bodybuilding competitors take as many as 60 Liver tablets a day in the off-season and 100 tablets the last few weeks prior to a competition)

Secret #2

Another of Vince's Anabolic Secrets that has proven to be beneficial in the promotion of muscular weight gains was to eat 1 **boiled egg** every hour that you are awake.

Secret #3

<p style="text-align: center;">Euro-Blast Weight Gaining BIG SECRET!</p>

Back in the 1960's the late, Vince Gironda "The Iron Guru" revealed to the bodybuilding world the Euro-Blast Weight Gaining **BIG SECRET** that the European muscle monsters were using to gain muscle density. Vince began using it on his students to increase their body weight by as much as 40 pounds.

The **BIG SECRET** is simply drinking 6 ounces of half and half or certified raw cream mixed with 6 ounces of ginger ale. Sometimes to trigger the anabolic or growth mechanism of the body further yet Vince would advise adding 2 ounces of a milk & egg protein powder.

The students at Vince's Gym in Ventura, California enjoyed this drink as a daily in-between meal pickup at 10 a.m. – 2:00 p.m. and 4:00 p.m.

BLENDER MAGIC

To add some variety to your daily nutritional regimen, you might find it refreshing to try one or more of the 45 blender drinks (i.e. shakes) listed on the following pages. These drinks can be used as a part of your muscular bodyweight gain program; you can substitute one of these drinks for a meal or snack. Adding these drinks to your daily diet, especially the “7” **Get Mass Blender Shake Recipes**; will help you obtain those extra calories so necessary for gaining muscular body weight.

Blender drinks are a good way to get needed calories, but they contain a tremendous number of *concentrated* calories, so it is very easy to drink more calories than you would normally eat at a particular meal.

Then again, you may find that some of these drinks have fewer calories than you need for a particular meal replacement. In this case, you could double the ingredients, and hopefully this would ensure that you receive adequate calories. Or you might use the drink in conjunction with some solid food selections.

To prepare each of the drinks below, simply whirl the ingredients in an electric blender (Vita-Mix®) until smooth. Each recipe makes at least one or more servings.

Note: All the calorie counts listed on select blender drink are approximations only.

*An asterisk denotes that a select blender drink contains an unaccounted number of mega -calories.

“7”

Get Mass Blender Shake Recipes

Get HUGE Drink

This drink was first published back in the 1960's in Strength & Health magazine by John McCallum in his “Keys To Progress” series.

3000 calories – 200 grams protein

2 quarts milk
2 cups skim milk powder
2 eggs (boil eggs 15-20 sec.)
2 tablespoons gain weight powder
4 tablespoons natural peanut butter
½ brick natural ice cream
4 tablespoons malted milk powder
6 tablespoons corn syrup
1 small banana

*Australian Weight-Gain Drink

This weight-gain drink was donated to the bodybuilding community almost 40 years ago by the famous Australian bodybuilder Wayne Gallasch (www.gmv.com.au).

Water (see instructions below)
½ cup natural honey
1 cup safflower oil
1 ½ cups Ovaltine
3 egg whites
1 cup brewer's yeast powder
2 cups GROW! Classic Vanilla Protein Powder
6 cups skim milk powder
Pure vanilla extract to taste

Mix the ingredients in the order listed, adding cold tap water as the mixture thickens, until you have approximately 7 pints of liquid. (Water is used rather than milk to keep the drink's fat content low and its cost reasonable.) Occasionally, you might wish to add fresh cream, natural ice cream, powdered egg white, Knox gelatin, or malt.

Tip: This drink has a sweet, pleasant but very rich taste and as it is quite thick it is best to follow each mouthful of the drink with an equal amount of water to clear the mouth and throat.

Wayne claimed that this drink would put additional body weight on a bone rack.

***BONZAI GORILLA BIG BULK BOMBER WEIGHT GAIN DRINK FORMULA**

2 cups non-fat milk	2 tbsp. peanut butter
2 raw eggs	2 scoops ice cream
½ cup heavy whipping cream	2 tbsp. 100% egg protein
8 tbsp. powdered milk	1 banana

Mix ingredients in a blender at high speed for 20 seconds and drink entire amount twice daily in addition to regular meals.

***THE SERIOUS GROWTH SHAKE**

This blender shake is a Leo Costa Jr. favorite.
(Visit: www.otsdirect.com)

8 ounces Whole Milk*
1 Banana
4 Strawberries
4 ounces Half & Half
1 tbsp. Brewer's Yeast
Scoop of Ice Cream*
Scoop of Egg & Milk Protein

*If you have a lactose intolerance or don't want to use milk, substitute juice or soy drink for the milk and flavored yogurt for the ice cream.

Put the liquid and solid ingredients in the blender, put the top on and start blending. Take the top off, then add the protein and yeast into the center of the whirlpool created by the blender. Doing it this way keeps the powdered ingredients from caking on the sides of the blender.

This drink provides at least 500 calories per glass. I take the drink first thing in the morning, then again at night before bed.

Weight Gainer Supreme

12 oz. pineapple-coconut juice
8 oz. orange juice
3 ripe bananas
3 soft boiled eggs
1 tbs. flax seed oil
2 tbs. milk and egg protein
2 tbs. pure dairy whey
Ice

***Beverly's Mass Maker (www.bodybuildingworld.com)**

8-16 ounces half-and-half
2 eggs
1-2 servings of Beverly's Mass Maker
½ banana
1 teaspoon honey
1 scoop natural ice cream

***Gain Weight Protein Drink**

8 oz. certified raw milk
3 Tablespoons egg and milk protein
2 raw eggs
1 scoop ice cream
Honey (add to taste)
Strawberries or banana
1 Tablespoon tri-term oil

38-Optional Calorie Dense Blender Shake Recipes

Peanut Butter Shake

1 Quart whole milk
3 Tbs. creamy peanut butter
3 Tbs. protein powder
2 scoops vanilla ice cream
1 raw egg
Mix in blender

Pre-Workout Drink #1 (520 calories)

Equal amounts orange juice, apple juice, and papaya juice
to make 1 1/3 cups

1 tablespoon milk and egg protein powder
1 tablespoon flax seed oil
1 tablespoon lecithin powder
1 tablespoon raw honey
1 medium banana
5 frozen strawberries
1 cup crushed ice

Pre-Workout Power Drink #2

10 oz. fresh orange juice
6 oz. pure water
1 tbs. milk and egg protein
1 tsp. flax seed oil

Post-Workout Drink #1 (730 calories)

1 cup papaya juice
1/2 cup cold whole milk
1 tablespoon milk and egg protein powder
1 tablespoon lecithin powder
1 tablespoon flax seed oil
1 tablespoon raw honey
1 medium banana
5 frozen strawberries
1 cup crushed ice
2 large scoops of natural ice cream

Post-Workout Recovery Drink #2

6 oz. fresh apple juice
1 whole orange (de-seeded and peeled)
6 oz. pure water
1 tbs. milk and egg protein
1 soft boiled egg

Banana Flip (426 calories)

1 1/3 cups cold whole milk
1 medium banana
1 tablespoon raw honey
1 tablespoon milk and egg protein powder
1 cup crushed ice

Beatty Fruit Cocktail (240 calories)

Mix equal amounts apple juice, orange juice and papaya juice to make 1 1/3 cups.

5 frozen strawberries
1 cup crushed ice

Coconut Pro (440 calories)

2/3 cup apple juice
2/3 cup pineapple coconut juice
1 medium banana
5 frozen strawberries
1 cup crushed ice

Smoothie (247 calories)

2/3 cup orange juice
2/3 cup papaya juice
1/2 medium banana
1 tablespoon honey
1 cup crushed ice

Hawaiian Delight (225 calories)

2/3 cup papaya juice
2/3 cup pineapple coconut juice
1 medium banana
1 cup crushed ice

Orange Sunrise (430 calories)

1 1/3 cups orange juice
2 large scoops natural vanilla ice cream

Pina Colada (228 calories)

1 1/3 cups pineapple coconut juice
1 medium banana
1 tablespoon pure vanilla extract
1 cup crushed ice

Diet Delight (172 calories)

8 ounces papaya juice
1 tablespoon milk and egg protein powder
3 fresh or frozen strawberries

Strawberry Fruit Flip (297 calories)

1 1/3 cups papaya juice
5 frozen strawberries
1/2 medium banana
1 tablespoon raw honey
1 cup crushed ice

Instant Energizer Drink (328 calories)

8 ounces natural fruit juice
1 egg
1 tablespoon milk and egg protein powder
1/2 banana
1 teaspoon raw honey

Citrus Energy Drink (650 calories)

1 whole orange
1 whole lemon
1 pint unsweetened pineapple juice
1,000 IU vitamin E (d-alpha)
2 tablespoons flax seed oil
3 tablespoons malted milk powder
Raw honey

Grate off the outer oily rind of the citrus fruits until there is no color left and discard colored rind. Chop pulp, removing seeds, and blend the fruits with pineapple juice. Then mix in vitamin E, Hoffman's Energol, malted milk powder, and enough raw honey to make this drink taste decent. Drink one-third of this drink three times per day.

Cabana-Banana Shake

1 quart whole milk
1/2 c. Carnation instant milk
2 bananas
3 scoops vanilla cream ice
Mix in blender

Cherry-Bomb Shake

1 quart of whole milk
½ cup instant milk
Handful of Maraschino cherries
3 scoops vanilla ice cream
Mix in blender

Frozen Banana Malt (595 calories)

Ingredients:

1 banana, frozen	(135)
1 cup whole milk	(150)
1 ounce chocolate flavored malted milk powder	(110)
½ cup vanilla ice cream	(200)

Slice the frozen banana and add to blender with milk and malted milk powder. Turn blender on and mix. Add ice cream and continue to mix until blended. Pour in glass and enjoy.

Honey Egg Nog Shake (565 calories)

Ingredients:

1 tablespoon honey	(55)
Dash of salt	
2 eggs, raw	(160)
1 cup whole milk	(150)
¼ teaspoon vanilla	
½ cup vanilla ice cream	(200)
Dash of nutmeg	

In a blender, whip honey, salt, and eggs well. Stir in the milk and vanilla. Add ice cream. Do not over blend. Pour in a glass and sprinkle nutmeg over the top.

Peach Shake (565 calories)

Ingredients:

½ cup peach nectar	(70)
¾ cup whole milk	(113)
1 tablespoon safflower oil	(125)
¾ cup peach ice cream	(300)

In a blender, mix all the above ingredients until well blended. Pour into a tall glass and drink.

Pure Power Shake

8 oz. Fresh apple juice
8 oz. pure water
2 ripe bananas
1 soft boiled egg
2 tbsl. milk and egg protein powder

The Famous “Banana Delight” Shake

12 oz. nonfat milk
1 tbsl. milk and egg protein
1 ripe banana
1 tsp. flax seed oil
Ice

Super Slimmer Shake

8 oz. fresh apple juice
8 oz. pure water
2 tbsl. milk and egg protein
1 tsp. flax seed oil
5 strawberries
Plenty of ice

Cut To The Bone (pre-contest diet drink)

12 oz. pure water
4 oz. fresh orange juice
5 strawberries
2 tbsl. milk and egg protein
1 tsp. dairy whey
1 tsp. flax seed oil
Plenty of ice

BODY BY JAY Supreme (www.jayrobb.com)

8 oz. pure water
2 ripe bananas
6 oz. fresh orange juice
6 ripe strawberries
2 soft boiled eggs (boiled for 1 minute only)
1 heaping tbsl. whey powder
2 heaping tbsl. milk and egg protein
2 tsp. flax seed oil
Ice

Hi Energy Protein Drink

12 oz. water
4 oz. cream
2 raw eggs
¾ cup milk-egg protein powder
fresh or frozen sugarless strawberries
3 teaspoons glycerin or sweeten to taste

1. In a blender add water, cream, raw eggs and mix. While mixing, add strawberries. Then add protein powder a little at a time and sweeten to taste with glycerin. Glycerin or glycerol can be obtained in any drug store.

Lo Carb Protein Drink

12 oz. water
3 oz. cream
1 raw egg
1 cup protein powder

In a blender add cream and raw egg and mix. While mixing add protein powder slowly and sweeten to taste with any flavor gelatin dessert mix (D-zerta).

Dieter's Protein Drink (Zero Carb)

6 oz. water
4 egg whites
1 packet 1-calorie sweetener
3 Tablespoons egg and milk protein
1 capful vanilla extract

Banana-Nana Shake

2 cups cold 2% milk
2 Tbs. non-fat French Vanilla liquid creamer
1 frozen banana (peel and wrap in plastic wrap prior to freezing)
1 tsp. banana extract
1 packet Fuel Plex, vanilla

Combine all the ingredients in a blender and blend on highest setting until thick and smooth.

This shake contains:

Calories: 624	Carbohydrates: 82g
Protein: 63g	Fat: 7g

Pineapple Cream Shake

2 cups ice cold 2% milk
2 Tbs. non-fat French vanilla liquid creamer
2 Tbs. frozen pineapple juice concentrate
1 tsp. vanilla extract
1 packet (Twin Labs) Fuel-Plex, vanilla

Combine all the ingredients in a blender and blend on highest setting until thick and smooth.

This shake contains:

Calories: 600	Carbohydrates: 77g
Protein: 63g	Fat: 7g

Quick Drink #1:

16 oz. 2% low fat milk
 $\frac{3}{4}$ cup non fat dry milk
1 tablespoon of honey
1 tablespoon of malted milk powder

Blend ingredients together until smooth. This drink provides nearly 50 grams of protein and over 700 calories.

Quick Drink #2:

16 oz. unsweetened grapefruit juice
 $\frac{3}{4}$ cup non fat dry milk
 $\frac{1}{2}$ cup evaporated milk
2 packets of gelatin
1 tablespoon of honey

When blended, this will give you 60 grams of protein and nearly 1,000 calories. Drink this if you are bulking up or need to gain added weight.

Quick Drink #3:

12 oz. unsweetened pineapple juice
1 large ripe banana
 $\frac{1}{2}$ cup evaporated milk
2 packets of gelatin

This provides a great fruity taste but surprisingly, it has close to 29 grams of protein and only 11 grams of fat. Calories come in at about 630 grams.

Quick Drink #4:

12 oz. 2% low fat milk
4 oz. orange juice
1 medium banana
2 packets of gelatin
1 tablespoon of malted milk powder
4 oz. evaporated milk

Power Pineapple Shake

10 oz. pineapple juice
1 medium banana
1 egg white
1 tablespoon wheat germ oil
1 scoop low-fat strawberry natural ice cream
2 scoops of milk & egg protein powder

Strawberry Delight Shake

10 oz. of skim milk
½ cup fresh or frozen strawberries
2 egg whites
1 scoop low-fat strawberry natural ice cream
1 tablespoon wheat germ oil
3 tablespoons low-fat strawberry yogurt
2 scoops of milk & egg protein powder

Orange Crush Shake

10 oz. orange juice
1 medium banana
1 tablespoon wheat germ oil
2 egg whites
2 scoops low-fat orange ice cream
2 scoops milk & egg protein powder

After working with these blender shake recipes, you can see how simple it is to snack your way to increased muscular mass and strength gains.

Prepare each drink in a blender and add ice if desired. The more ice you add, the colder the drink will become. Most drinks require approximately 45 seconds blending time. For a special treat, serve each drink in a frozen glass with a slice of orange on the side. Enjoy!

SIGNS OF GAINING WEIGHT TOO QUICKLY

A need for more sleep than usual, shortness of breath, lack of energy, and excessive sweating are all signs that you've gained muscle weight too quickly.

Many bodybuilding authorities say that you generally can't gain more than 10-12 pounds of muscle body weight in 12 months. This is generally true for some advanced bodybuilders, especially the seasoned pro competitors.

Be assured that a beginner or an intermediate bodybuilder may realize some rather exceptional gains, as evidenced in the **Gain 25 Pounds in (A) 21 Day (Mass Up Cycle)** e-report, in muscular body weight beyond those just mentioned.

Monitoring Tools

Some monitoring tools that you will find helpful in your quest for gaining muscular body weight are a measuring tape, a mirror, and an accurate bathroom scale. If you are in the process of gaining weight, be sure to weigh yourself during the evening around 8:00 p.m. or prior to retiring to bed, because that is when you will be your heaviest.

Bonus Report No. 3

SPECIAL 118-DAY SCIENTIFIC BB'ING EXPERIMENT

Exercise Course & Mega-Vitamin/Mineral Regime

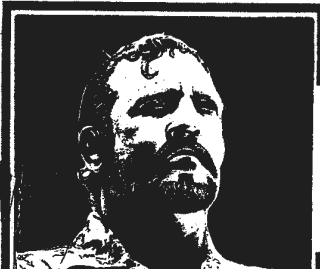

by

Ernest F. Cottrell

Author of the popular BODYBUILDER'S COOK-BOOK, inventor of the unique "Maxi-Sizer" equipment, ex-Editor, feature writer and researcher for two World-Wide Bodybuilding Magazines. He has also been owner, operator and instructor of many bodybuilding gyms and health centers where he has functioned as physical therapist and nu-

tritionist...as well as trainer of Bodybuilders/Powerlifters/Olympic lifters.

Now, he has established a small but dynamic 1-man business to service the bodybuilders of all types with very personal and highly professional instruction in all phases of physical excellence...!

Introduction...

Having been heavily involved in nutrition for almost 3 decades (1948-1975), especially in the field of bodybuilding and power-lifting of all types – **Ernest F. Cottrell** occasionally experimented on himself and special personal and bodybuilding mail-order students to prove-out certain theorems of exercise and nutrition.

It was through this research and analysis that he was able to design exercise routines and diets that gave him the utmost in bodybuilding results in a very short time. In other words, he found a way to "anabolize" his body and create a positive nitrogen balance for very rapid muscle gains...much like that which is obtained by the common and dangerous use of anabolic steroids and/or thyroid drugs – but without the possible harm involved.

Ernest would constantly re-test and modify his programs of exercise (routines) and diet so that everyone using them will make progress to some degree – some to the point of 2 to 3 times the bodybuilding progress they've previously realized...!

His mission was for bodybuilders to start making progress for all the hard months and years of bodybuilding effort they were expending...!

Thus the **SPECIAL 118-DAY SCIENTIFIC BB'ING EXPERIMENT Exercise Course & Mega-Vitamin/Mineral Regime** was developed. Here is an overview of the program exactly as Ernest F. Cottrell designed it.

NOW...THE EXERCISE COURSE

The exercise course consists of a slightly unusual weight-training routine that changes every month, plus a refreshing “1-Week Preparatory Workout” that is used just before, and in-between the regular course.

The following Exercise Course is a 6-day-a-week schedule...each body-part is directly exercised twice per week. This has proven to be the most effective (1975) schedule with most bodybuilders. The exercise sequence and rest periods are rather critical, so be sure to follow the routine carefully.

This Exercise Course uses a minimum of equipment so you guys working-out in your basement with only basic equipment can progress along with the guys in a fancy, well-equipped gym.

Here’s the exercise “outline” showing the exercise sequence and rest between exercises. The exercise performance and Ernest F. Cottrell’s reproduced illustrations (line drawings) follow this “outline”, beginning on page 89.

1ST WEEK:

No exercise; completely lay-off all exercise for one full week.

2ND WEEK:

1-WEEK ‘PREPARATORY’ WORKOUT:

[After you completely lay-off all exercises for one full week, start the following “1-Week Preparatory Workout.” It is designed to “**shock**” your system and prepare it for the 3-Month Exercise Course that follows. Here’s an “outline” of the 1-Week “Preparatory Workout:”](#)

MON-WED-FRI:

- 1) Squats with a barbell $\frac{1}{4}$ of your body weight.
- 2) Body-weight-only Parallel bar dips.
- 3) Triceps exercise with $\frac{1}{3}$ of the poundage you’d normally do for a 10-rep maximum. You choose the exercise. I happen to like the close-grip (6”) bench presses using an EZ curl bar.

TUES-THURS-SAT:

- 1) Underhand-Grip Bodyweight Only Chin-Ups.
- 2) Abdominal Work (Your Choice).
- 3) Biceps Exercise (Your Choice, & $\frac{1}{3}$ rd weight).

All of the exercises listed above should be done for 1 set, using the optimum muscle-blasting technique “cumulative repetitions” (refer to page 29 and/or the addendum at the conclusion of this e-report for an in-depth description)

3rd-6th Week:

Follow the 6-Day-A-Week One Month Barbell Workout as outlined in the first column(s) for sets and reps.

7th Week:

Completely rest on Monday, Tuesday and Wednesday...then do the 2nd-week ‘Preparatory’ Workout on Thursday (all 6 of the exercises); then rest again on Friday, Saturday and Sunday.

8th-11th Week:

Follow the 6-Day-A-Week One Month Barbell Workout as outlined in the second column(s) for sets and reps.

12th Week:

Same as the “7th Week.”

13th-16th Week:

Follow the 6 Day-A-Week One Month Barbell Workout as outlined in the third column(s) for sets and reps.

MONDAY/THURSDAY (Chest & Back)	<u>Weeks 3-6</u> SETS/REPS	<u>Weeks 8-11</u> SETS/REPS	<u>Weeks 13-16</u> SET/REPS
<u>1</u>			
* <u>Repetition Deadlift</u>	5 X 6	4 X 8	4 X 10
* <u>Parallel Bar Dips</u> (Super-set these 2 with no rest between sequences.)	5 X 6	4 X 8	4 X 10
<i>Rest 5 minutes; then:</i>			
<u>2</u>			
<u>Bent-Over Rowing</u>	4 X 8	4 X 10	4 X 10
<u>Stiff-Arm Pullover</u>	4 X 12	4 X 15	4 X 20
<u>Bent-Arm Flying</u> (Tri-set these 3 without rest between sequences)	4 X 10	4 X 12	4 X 15
<i>Rest 5 minutes; then:</i>			
<u>3</u>			
<u>Body-Weight Underhand Chins</u>	5 X Failure	5 X Failure	5 X Failure
<u>Body-Weight Seated-Position Dips</u> (Super-set these 2, resting 45 seconds between sequences)	5 X Failure	5 X Failure	5 X Failure
Note: Whenever you see asterisks (*), this means you should “warm-up” by doing 2 sets of 15 reps with this exercise with about 2/3rds the amount of the exercise weight.			

TUESDAY/FRIDAY (Arms & Shoulders)	<u>Weeks 3-6</u> SETS/REPS	<u>Weeks 8-11</u> SETS/REPS	<u>Weeks 13-16</u> SETS/REPS
<u>1</u>			
* <u>Seated Barbell Curl</u>	4 X 8	5 X 10	5 X 12
* <u>Supine Tricep Extensions</u>	4 X 8	5 X 10	5 X 12
<u>Close-Grip Barbell Curls</u>	4 X 12	5 X 15	5 X 15
<u>Standing Triceps Press</u>	4 X 12	5 X 15	5 X 15
(Quad-set these 4, rest 1 minute after each sequence)			
(Use an E-Z curl bar for both triceps exercises)			
<i>Rest 5 minutes; then:</i>			
<u>2</u>			
* <u>Narrow-Grip Upright Rowing</u> (with a 10" grip)	4 X 8	4 X 10	5 X 12
<u>Seated Front Arm Raise</u>	4 X 15	4 X 15	5 X 15
<u>Expander "Chest Pull"</u>	4 X 15	4 X 15	5 X 15
(Tri-set these 3, rest 2 minutes after each sequence)			
<i>Rest 5-10 minutes; then:</i>			
<u>3</u>			
<u>Hand Gripper</u> (No rest; alternate hands)	3 X to Failure	3 X to Failure	3 X to Failure
No rest; then:			
<u>4</u>			
<u>Dumbbell Wrist "Rocker"</u> (No rest; alternate arms)	3 X 8	3 X 8	3 X 8

WEDNESDAY/SATURDAY (Legs & Waist)	Weeks 3-6 SETS/REPS	Weeks 8-11 SETS/REPS	Weeks 13-16 SETS/REPS
<u>1</u>			
*<u>Bench Squats</u> (Bench should be a height that will allow you to squat 2 inches below parallel.)	4 X 6	4 X 8	4 X 10
*<u>High Bicep Curls</u>	4 X 10	4 X 12	4 X 15
<u>Full Front Squats</u> (Tri-set these 3, rest 2 minutes after each sequence)	4 X 12	4 X 12	4 X 15
<i>Rest 3 minutes; then:</i>			
<u>2</u>			
<u>Hack-Lift Squat-Tense</u> (This exercise is done in regular straight set fashion, resting only 30 seconds to 1 minute) (Mentally tense the thighs at the top of the movement for a 2-second squeeze.)	2 X 10	2 X 12	2 X 15
<i>Rest 2-3 minutes; then:</i>			
<u>3</u>			
<u>1-Leg Rise-on-Toes</u> (No rest; alternate legs.)	5 X 6	5 X 10	6 X 15
<i>Rest 5-8 minutes; then</i>			
<u>4</u>			
<u>Bent-Legged Situps</u>	5 X 10	5 X 15	5 X 20
<u>Overhead Sidebends</u>	5 X 20	5 X 25	5 X 30
(Superset these 2 with absolutely no rest between sequences)			

17th Week:

No exercise; completely lay-off all exercise for one full week.

18th-21st Week:

For one month do the exercise program you were doing prior to the **Special 118-Day Scientific BB'ing Experiment** or perhaps you might enjoy doing one of the two following **THREE-DAYS-A-WEEK TOTAL BODY SYSTEM WORKOUTS.**

NO. 1 **MIAMI BEACH** **WORKOUT**

Monday-Wednesday-Friday

Or

Tuesday-Thursday-Saturday

Flat Barbell Bench Press
Parallel Bar Dips w/Weight
Incline Dumbbell Flyes
Barbell Triceps Extension
Close Grip Lat Pull-downs
(to chest)
Straight Arm Barbell Pullover

These 6 exercises make one sequence, with no rest between. Repeat the sequence SIX times, 8 reps for each exercise.

***Gironda Perfect Curls**
Close Grip Chins

Super-set these two exercises for 6 sets of 8 reps.

Barbell Front Squats
Machine Leg Curl

Super-set these two exercises for 6 sets of 8 reps.

Calf Raise on Leg Press Machine

6 sets of 30 reps (10 reps, each foot position)

Incline Sit Ups
Hanging Leg Raises

4 sets, with weight.
4 sets, with weight.

Every-Other-Day Split Routine:

If you don't have the impetus to complete the Miami Beach Workout in its entirety then I suggest you consider the Every-Other-Day Split Routine.

JUST WHAT IS THE EVERY-OTHER-DAY SPLIT ROUTINE?

Simple stated it means that you train on the following rotating workout schedule.

1st DAY-TRAIN LEGS AND ABDOMINALS
2nd DAY-REST & RELAXATION
3rd DAY-TRAIN UPPER BODY
4th DAY-REST & RELAXATION
5th DAY-TRAIN LEGS AND ABDOMINALS
6th DAY-REST & RELAXATION
7th DAY-TRAIN UPPER BODY

CONTINUE FOLLOWING THE ROTATING WORKOUT SCHEDULE INDEFINITELY.

***[Gironda Perfect Curl:](#)**

The late, Vince Gironda, the originator of the Perfect Curl (or complete curl) described how to do it in the following manner.

The **first part** of “The Perfect Curl” (using a straight bar and a shoulder width hand spacing) begins with the elbows resting on the pelvis or hip bones with the arms hanging straight and the upper torso inclined with the head and shoulders just back of the hips. This particular starting position will actively stimulate the lower insertion of the biceps as the barbell is curled upward the first 10-12 inches.

The **second part** of “The Perfect Curl” kicks in as the barbell is continuing to be curled upward and the upper torso (head and shoulders) begins to travel forward to an erect (or vertical) position. This part of the curl involves the belly of the biceps.

The **third part** of “The Perfect Curl” concludes with the upper torso (head and shoulders) moving slightly forward from an erect (or vertical) position and the bar is curled upward to completion. When the torso is slightly forward from vertical at the completion of the upward phase of the curl it creates a maximum peak contraction in the biceps. Cramp the barbell into the top curl position and contract the biceps for all they are worth for a second and then reverse the procedure as you lower the barbell to the starting position. This completes one rep! Each rep should take approximately 6 seconds to complete.

Always use poundage that you can handle in the form described above, perhaps with about 60 percent of your maximum single barbell curl. Vince suggested doing one of the following sets and reps schemes; 6 sets of 6 reps, or 8 sets of 8 reps and finally 10 sets of 10 reps. Rest-pause, 20-30 seconds between each set of the chosen set and rep scheme.

NO. 2
THREE-DAYS-A-WEEK
CONCENTRATED BODY BLAST WORKOUT(S)

The following three Concentrated Body Blast Workouts (popularized in the 1980's by a Maj. Donald V. Clerkin) are most result producing in that they concentrate on the seven basic body groups-thighs, chest, back, shoulders, arms, calves and abs.

Monday's workout consists of the heavy core building exercises for muscle growth. Do not add or substitute exercises on this training day. However for the other two training days you can substitute one body part exercise for another. For example on alternate Wednesdays you could substitute Barbell Bent-Arm Pullovers for Barbell Bent-Over Rowing and on alternate Fridays, do Hack Machine Squats instead of Leg Extensions. The combinations are endless.

Three sets are generally performed for each exercise with the first set being a warm-up using relatively light to moderate weights. Go all out on the remaining two sets. While three sets seem to be just about right for muscle stimulation some bodybuilders may find that a fourth or fifth set (at most) is necessary on some exercises. You will have to experiment a bit to determine if this is the case for you. Each of the workouts should take approximately 60-90 minutes to complete.

The following is an outline of the **Three-Days-A-Week Concentrated Body Blast Workout(s)**.

Monday

Barbell Back Squat	
3 sets	15-9-7 reps
Flat Barbell Bench Press	
3 sets	12-7-5 reps
Conventional Dead lift	
3 sets	12-7-5 reps
Barbell Press Overhead	
3 sets	12-7-5 reps
Barbell Curl	
3 sets	12-7-5 reps
Standing Calf Machine Heel Raises	
3 sets	15-20 reps
Abdominal ¼ Crunches	
3 sets	20-40 reps
Seated Twists (with broom stick)	
3 sets	20-40 reps

Wednesday

Barbell Front Squats	
3 sets.....	15-9-7 reps
Incline Barbell Press	
3 sets.....	12-7-5 reps
Barbell Bent-Over Rowing	
3 sets.....	12-7-5 reps
Barbell Press Behind Neck	
3 sets.....	12-7-5 reps
E-Z Bar Reverse Curls	
3 sets.....	12-7-5 reps
Seated Calf Machine Heel Raises	
3 sets.....	15-20 reps
Incline Bent Knee Sit-Up	
3 sets.....	20-40 reps
Incline Leg Raises	
3 sets.....	20-40 reps

Friday

Leg Extensions	
3 sets.....	15-9-7 reps
Flat Dumbbell Flyes	
3 sets.....	12-10-8 reps
Barbell Power Cleans	
3 sets.....	12-7-5 reps
Seated Dumbbell Lateral Raises	
3 sets.....	12-10-8 reps
Seated E-Z Bar Triceps Press	
3 sets.....	12-10-8 reps
Donkey Heel Raises	
3 sets.....	15-20 reps
Hanging Leg Pull-Ins	
3 sets.....	20-40 reps
Seated Barbell Twists	
3 sets.....	20-40 reps

After four weeks of doing the above workout routines you can do the **Special 118-Day Scientific BB'ing Experiment** again if you desire (usually once per training year is enough for most natural drug free bodybuilders), beginning with the first week (Ref: pg. 81).

The final factors to be considered in the **Special 118-Day Scientific BB'ing Experiment** is: EXERCISE PERFORMANCE, HOW MUCH WEIGHT, WHEN TO ADD MORE, HOW MUCH REST? and the MEGA-VITAMIN/MINERAL REGIME. Here's a brief overview of each of these factors...

EXERCISE PERFORMANCE
for the
Special 118-Day Scientific BB'ing Experiment

MONDAY – THURSDAY

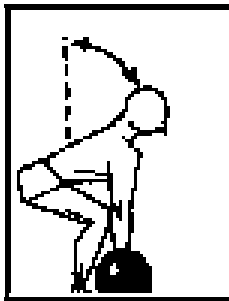

- 1A: **REPETITION DEADLIFT**: Hold bar with hands 18” apart, palms facing you, keep back flat, knees bent; then stand up with barbell until body is straight – lower and repeat, just barely touching floor with barbell. Now, immediately go to the next exercise:

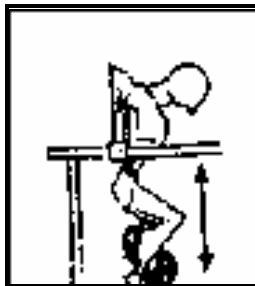

- 1B: **PARALLEL BAR DIPS**: Grasp parallel bars with regular grip (palms facing down with your body between the bars), then proceed to “dip” from arms’ length up high, to very low. Add weight around waist if you need more weight. Now, immediately go back to (A) and do another set, then back to (B), etc., until all sets are done on both.

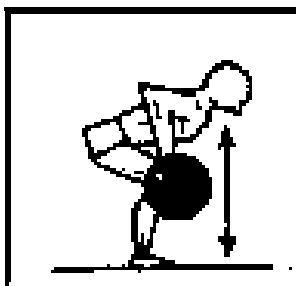

- 2A: **BENT-OVER ROWING**: Bend over, back flat, legs slightly bent, grasp bar as in Deadlift, but now you don’t stand up; instead, you pull barbell bar up into stomach area as high as possible, and then lower and repeat for 1 set. Now, immediately go to:

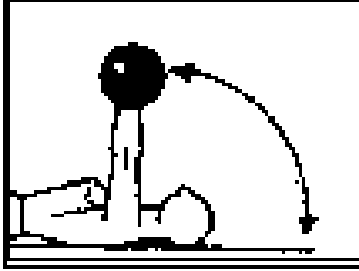

2B: **STIFF-ARM PULLOVER**: Lie on floor, barbell on floor behind your head; then grasp bar with arms stiff and raise it up over your head as you exhale air; lower while taking a deep breath and repeat. Now, go immediately to:

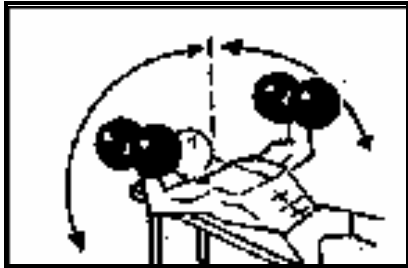

2C: **BENT-ARM FLYING**: For a deep armor-plated chest! Lie on an incline exercise bench, hold dumbbells over your chest, arms straight; then proceed to lower dumbbells to sides, bending arms slightly, as low as possible while inhaling deeply – return, while exhaling and repeat for 1 set. Okay, now go back to (A), (B) and (C) again and do all the sets without rest.

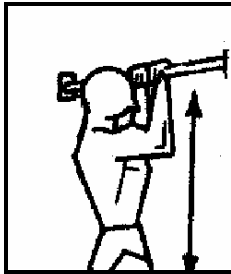

3A: **BODYWEIGHT UNDERHAND CHINS**: Do as you would regular chins but use underhand grip (palms facing you) and hands about 4” apart; be sure to “stretch” at bottom and hold a moment at top. Now, immediately to:

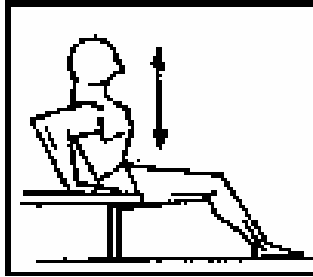

3B: BODYWEIGHT SEATED-POSITION DIPS: Sit between 2 exercise benches or chairs and place hands on each; then proceed to do “dips” between them. Inhale deeply when lowering. Now, rest 20 seconds and start all over again until all sets are done.

TUESDAY – FRIDAY

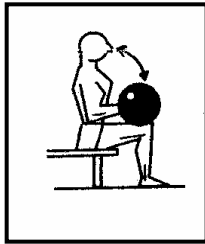

- 1A: **SEATED BARBELL CURL**: Sit as shown, rest barbell across thighs; then proceed to curl bar from thighs up to the chest area, trying not to move elbows! Lower and repeat for a set. Now immediately go to:

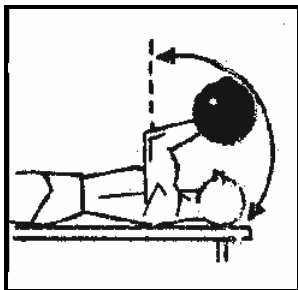

- 1B: **SUPINE TRICEP EXTENSIONS**: Start with barbell overhead; then proceed to lower bar to bench behind head (don't move elbows much). Return and repeat for a set. Now, immediately go to:

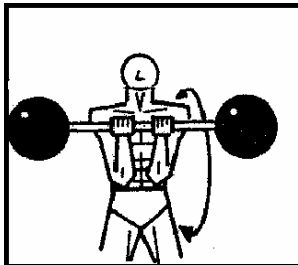

- 1C: **CLOSE-GRIP BARBELL CURLS**: Just like reg. standing curls, but with your hands only about 6" apart, and your elbows placed against your stomach. Do a set, then immediately go to:



- 1D: **STANDING TRICEP PRESS**: Using a close grip (hands about 4-6 inches apart). Hold barbell overhead, palms forward; then proceed to lower the bar behind the head as far as possible without moving the elbows. This is important! Pause just a second in the low position so you won't "bounce" the bar back up; make the triceps do all the

work. Raise barbell back up to starting position and repeat. Inhale when lowering, exhale when raising the barbell. After this set, rest 1 minute and repeat this 4-exercise sequence again, and again...’til all sets are done for each exercise.

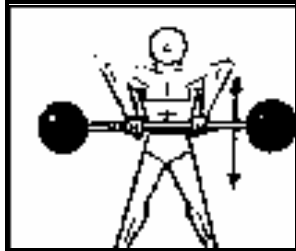

2A: **NARROW-GRIP UPRIGHT ROWING**: Hold barbell with hands 10” apart and pull up high to chest with body straight; lower and repeat for a set. Go right to:

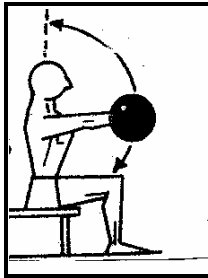

2B: **SEATED FRONT ARM RAISE**: Sit as shown, rest bar on thighs; then proceed to raise bar overhead with arms stiff. Lower and repeat for a set. Go right to:

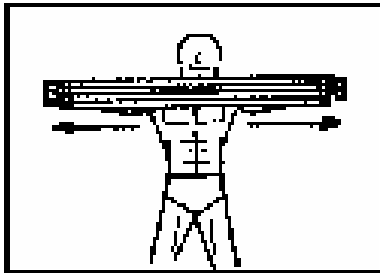

2C: **EXPANDER “CHEST-PULL”**: Hold cables out to front, arms straight; then pull apart until cables are against chest. Return and repeat for a set. Now, rest 2 minutes, then repeat until all sets are completed on each exercise.

3: **HAND GRIPPER**:(Not shown) Use regular “nutcracker” type forearm gripper. Buy a stronger one (www.ironmind.com) as you become stronger. Grip it hard!

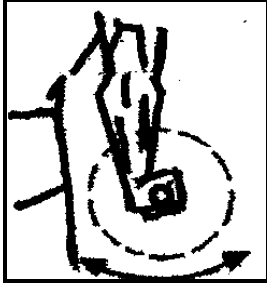

- 4: **WRIST "ROCKER"**: For a powerful grip and rippling forearm muscles!
Simple to do-but exceedingly result-producing. Hold fairly "heavy" dumbbell in each hand at your sides, out slightly from your body, palms in; then proceed to bend the wrists, curling the DB's inward, 'till the forearm muscles "cramp," hold about 2 seconds, then bend the wrists in the other direction, outwards, in the same manner. Don't move the arms or bend the elbows . . . it's all in the wrist action. You will be able to use fairly heavy dumbbells in this one. This exercise will make those stubborn, powerful forearms scream if you do the exercise correctly. No special breathing necessary.

WEDNESDAY – SATURDAY

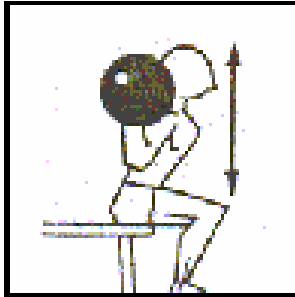

- 1A: **BENCH SQUATS**: same as reg. squats, but you lower yourself down to an exercise bench; return and repeat. Just barely touch bench; don't rest on it. Do a set, then go right to:



- 1B: **THIGH BICEP CURLS**: Either use a Leg Curl machine, or have a training partner offer resistance. Do a set, then go right to:



- 1C: **FULL FRONT SQUATS**: Hold the barbell at chest, palms to the front and the elbows out to front to secure the heavy barbell at the chest; then proceed to do full squats (all the way down). Return to the starting position and repeat without more than a moment's hesitation. Inhale while squatting, exhale while standing up. You may place a 2" X 4" block under your heel if you like. Do a set, then rest 2 minutes before doing another 3-exercise sequence...then again until all 4 sets are done.



- 2: **HACK-LIFT SQUAT-TENSE**: Hold barbell behind body as you stand up straight; then squat down until barbell just barely touches floor. Rise and then tense your thighs hard for a second, then lower and repeat.

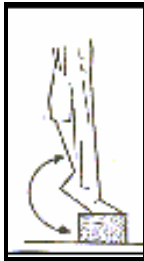

- 3: **1-LEG RISE-ON-TOES**: Reg. calf raise, but on 1 leg at a time. At top, tense calf 3 times hard, then at bottom, be sure to “stretch” calf 3 times each rep.



- 4A: **BENT-LEGGED SITUPS**: Best all-'round abdominal exercise! Sit, as shown, or on an inclined abdominal board, legs bent as far as possible, secure feet under something, clasp hands behind neck (across chest at first if too hard behind neck); then proceed to sit-up until your head is between your knees. Blow-out hard through tightly compressed lips as you sit-up, inhale freely as you lower back to the floor. Don't rest back on floor! (Note: as you get stronger, bend the legs more 'til the heels are touching your buttocks). Do a set, then go right to:



4B: **OVERHEAD SIDEBENDS**: Hold light weight above head, feet about 30” apart; then bend from side-to-side as shown. Over and back is 1 rep. Do a set, then immediately go back to (A) and Super-set these two until all sets are done.

HOW MUCH WEIGHT? WHEN TO ADD MORE... HOW MUCH REST?

WHAT WEIGHT? To determine what exercise poundage to use (in the Special 118 Day Scientific BB'ing Experiment), Ernest F. Cottrell preferred these two methods:

1. With each different exercise, use a weight that is slightly difficult to do for the prescribed amount of reps on the 1st set (After a good warm-up). The second set should be much harder to do, and the third set will be about the limit of your strength to do all the reps; the sets after that should require you to resort to a slight “cheating” movement to do all the prescribed reps per set. Add Weight (from 2 ½ to 5 lbs.) as your strength increases.
2. Another method that is very good is to use a weight that is heavier than normal so that you can only do 1 or 2 reps less than the prescribed amount; then, as your strength increases and you can do more reps (up to 2 extra reps), add weight so that you are again doing 1 or 2 reps less...and repeat.

NOTE: Whichever method you choose to use, be sure that the muscle “pumps” hard and “burns” a lot after all the sets are done! Use more weight if this doesn't happen. This “burn” should go away in a few minutes, or so.

REST PERIODS: Use a clock that has a second hand and measures the minutes and seconds accurately. THIS IS IMPORTANT! If, for instance, you are doing a “Super-Set”, you go from one exercise to the other, and back to the 1st, etc., without resting, but you do really rest one set of muscles as the other set works. Some “Tri-Sets” and “Quad-Sets” may be done this way, too, and some require a rest period after their multiple-set sequence, so read the “Outline” for these rest periods.

When you are doing only one exercise (not super-sets, tri-sets, or quad-sets), rest only 30 seconds between sets to no more than 1 full minute. You will have to determine just what your own recuperative powers are here (how long you need to rest)...and when you decide to rest (say 30 sec.), then stick with this time faithfully!

The MEGA-VITAMIN/MINERAL REGIME

Ernest did not actually go into detail about vitamins and minerals since there were at the time thousands of books and scientific papers written about them; but he did make a few comments (please keep in mind that the following theorems were what he knew to be true in 1975):

1) It's true vitamins and minerals are oftentimes prescribed individually (1 or 2 prescribed in huge doses out of proportion to the rest), and some "good" results are observed practice (in ill persons), but I don't recommend this since they are very definitely synergistic in nature with-in our systems; i.e., vitamins and minerals need to be used in various proportions in order to be effective since they perform a joint action of discrete agencies in which the total effect is greater than the sum of their effects when acting independently.

In fact, some well-know nutritionists agree that when one particular vitamin and/or mineral is taken "excessively", it can cause serious deficiencies in others already in the system because it uses them up and their value is lost. I've noticed dramatic evidence of this! THIS IS IMPORTANT, so don't forget it!

2) Don't drink soda pop of any kind when eating, or for at least an hour after your meals, for it will neutralize the hydrochloric acid in your stomach and disturb digestion.

3) Don't take high-potency iron at the same time you take your vitamin E. Let about 4 hours or more elapse or the E will be very ineffective.

4) Eat your food slowly and thoroughly before you swallow it...and don't wash it down with liquids. Take liquids into the mouth and mix it with saliva and let it trickle down the throat slowly; "eat" liquids during meals.

5) The greatest "flusher" of vitamins B & C is water! They are extremely water-soluble, and excessive drinking of water and juices, etc, flushes them from our system. Anything that has a diuretic effect (promoting the discharge of urine) should be avoided unless you immediately replenish your supply of B and C; such things as beer, coffee, wine, tea, etc, should be either avoided, or kept to a minimum.

Bodybuilders, especially, have great thirsts, so this is another reason why the higher doses of vitamins and minerals...and why I suggest they be taken throughout the day rather than one or two times per day (with the exception of the B vitamins that are to be taken 2 or 3 times per day).

6) Take Bone Meal and vitamin C about 30 minutes before eating.

7) Take all other vitamins/minerals (including the B's) with, or directly after meals.

Okay, here's a list of the vitamin & mineral dosages necessary to get results. The B-Complex vitamins should be taken in a minimum of two (2) doses per day (one dose at breakfast, and the other with a small mid-afternoon meal about 2 hours before your evening workout.).

If you take the following formula of B vitamins in three (3) doses per day, take them at breakfast, lunch and supper. The formula might appear to be an enormous amount of tablets to take, but in many high potency "stress" B formulas, you will find most of the ingredients in 1 or 2 capsules, then you'll only have to buy a few of the very neglected ones separately.

I am giving you the full daily dosage, then you can divide them up into 2 or 3 smaller doses. BE SURE to take each dose in the exact proportion listed here; i.e., don't, for instance, take the B-1, B-2, B-6 and B-12 all together at one meal, then take the rest at another meal! NO, exactly 1/2 or 1/3rd of all of them each time you take them. Read this carefully. Also, some are measured in milligrams (mg.), and some in micrograms (mcg.), so don't confuse these two!

Daily Intake

...To Be Divided Into 2 or 3 Doses

B-COMPLEX VITAMINS:

B-1 – (Thiamine) -----	100 mg.
B-2 – (Riboflavin) -----	100 mg.
B-6 – (Pyridoxine) -----	150 mg.
B-12- (Cyanocobalamin or Cobalamin) -----	100 mcg.
PABA (Para-aminobenzoic Acid) -----	100 mg.
Panthenic Acid -----	50 mg.
Niacin (Preferred over Niacin amide) -----	250 mg.
Biotin-----	200 mcg.
Choline-----	500 mg.
Inositol-----	500 mg.
Folic Acid-----	10 mg.

OTHER VITAMINS:

A-----	25,000 Units
C (From Rose Hips) -----	2 Grams
D (Get from Bone Meal; listed later)	
E (d-alpha tocopheryl; in other E-complex oils) -----	1,200 Units
F (Bioflavonoid Complex; best source is in lemon and orange pulp just under the oil-bearing colored skin. Grate this outer skin off, then cut-up entire fruit and blend well to drinking consistency 60oz. fruit juice.) Drink 1 daily.	

MINERALS

Manganese-----	100 mg.
Iron-----	15 mg.
Zinc-----	60 mg.
Potassium-----	50 mg.
Magnesium-----	50 mg.
Bone Meal (Calcium & Phosphorous) -----	6 tabs. (10 grains ea.)

...and Lecithin-----40 grains

All other trace vitamins and minerals are found in sufficient amounts in a well-balanced diet.

OTHER SUPPLEMENTS:

Brewer's Yeast-----	8 tablets (7 ½ gr. each)
Alfalfa Tablets-----	12 tablets (8 gr. each.)
Kelp Tablets-----	12 tablets (7-1/2 gr. each)
Parsley Tablets-----	8 tablets (7-1/2 gr. each)

NOTE: All other vitamins, mineral, and supplements and supplements (besides the B vitamins) may be taken in small mixed doses throughout the day with many small meals, except, of course, the Bone Meal and vitamin C. In this way, you won't have to take enormous amount with 1 or 2 meals.

Take the high-potency vitamins and minerals on Monday through Friday...then take only the "Other Supplements" on Saturday and Sunday. During the 7th and 12th week, take only the "Other Supplements", but take a double dose each day.

GENERAL DIET INFORMATION

To determine just how many grams of protein, fats and carbohydrates, and how many calories to take for your physical type, etc, read my BODYBUILDER'S COOKBOOK carefully; it contains excellent general information about this...PLUS it has many delicious easy-to-prepare recipes that will supply your system with a variety of good foods full of natural nutritional elements, just for the serious bodybuilder...!

Epilogue-

Rather than have bodybuilders resort to anabolic steroids and thyroid drugs, I have designed the Special Vitamin/Mineral Regime which has proven to be as good -- even much better! -- than the practice of taking dangerous drugs. The truth is, only a few guys taking these drugs get anywhere (plus it holds the very dangerous threat of bodily harm!), and the old and inaccurate myth that anabolic steroids get the muscles you want in all cases is very wrong!

Have a nice workout...!

Ernest F. Cottrell

ADDENDUM

CUMULATIVE REPETITIONS EXPLAINED!

This is an optimum muscle-blasting technique at its best. This technique can be utilized in body weight-only exercises (incline sit-ups, parallel bar dips, pull-ups, pushups, seated-position dips, “Muscle Beach” sissy squats, one-leg squats, squat jumps, etc.)

To illustrate body-weight only exercises, let’s examine the parallel bar dip. This is performed with just your body weight, but in a unique manner. Do 1 rep, rest 10 seconds, do 2 reps, rest 5-10 seconds, do 3 reps, rest 5-10 seconds, and continue in this manner until you simply cannot exceed your previous repetition count.

For instance, if you get up to 10 reps and find that after a 5-10-second rest, you can’t do 11 reps in this exercise, this is where you consider the exercise completed for this particular workout.

The objective here is to accustom the muscles to accommodating more and more reps each workout until you can finish off with 25 reps. When you reach this number, you will have completed 325 cumulative reps overall.

I realize that a majority of the success in completing a body-weight only exercise is related directly to your weight. If you weight 175 pounds, you will, in most cases, have a much better chance of completing those 25 repetitions, than you would if you weight 200-plus pounds.

The instruction for free-weight exercises is somewhat different from that given for a body-weight only exercise. The exciting part about training with cumulative repetitions as it applies to free weights is the progressive levels you can place on your muscles.

This is accomplished by the repetition scheme you select. Let’s assume that you decide to use the high-bar Olympic-style squat for your exercise. The repetition selection you have chosen is 3-5 reps for power.

Use a poundage that will allow you to blast out these 3-5 reps in proper form. You are now ready to begin. Perform 1 rep of the high-bar Olympic-style squat; then put the barbell back into the squat rack and rest while counting off 10 seconds. Perform 2 reps, then take a 10-second rest; do 3 reps and take a 10-second rest, etc. until you can’t exceed your prior repetition count.

To clarify this, let's say that you have just worked up to 4 reps and find that after the 10-second rest, you can't do 5 reps in the particular exercise. At this point, you will terminate the high-bar Olympic-style squat for this workout session.

Continue from workout to workout using the same poundage until you are able to complete 8 reps successfully. After you have reached this goal, a poundage increase is in order. Add only enough poundage to drop your repetition scheme back down to a base of 3-5 reps and begin this cycle over again.

The beauty of this progression scheme is that you are using a repetition count at the beginning (3-5 reps) that maximizes your power, but when you have achieved your goal of 8 reps, you are accomplishing strength and size gains with a poundage that is approximately 4 percent greater than you would normally be able to handle.

As you might know this base repetition (3-5) can be used only with general exercises and in some cases, tendon-strengthening movement but never with specific (isolating or shaping) exercises because they will make you so susceptible to injury from maximum low-rep overloads.

The best way to apply the cumulative repetition plan to an isolation exercise is to begin with a poundage that is your best 10 rep maximum, i.e., Seated Dumbbell lateral raises, Incline dumbbell flies; Do 1 rep, rest 5-10 seconds, then 2 reps, rest 5-10 seconds...

*Dennis B. Weis is a Ketchikan, Alaska based power-bodybuilder. He is the co-author of 3 critically acclaimed books; **Mass! Raw Muscle** and **Anabolic Muscle Mass** (visit: www.amazon.com to read about it).*

He is also a frequent hard-hitting uncompromising freelance consultant to many of the mainstream bodybuilding magazines published worldwide.

**Contact Information: E-mail: yukonherc@kpunet.net
Website: www.dennisbweis.com**